



EZ-TorQ

Torque Analyzer

Manual v2

January 1, 2009.



Mountz, Inc.
Phone: (408) 292-2214
Fax (408) 292-2733
sales@etorque.com
www.etorque.com

Heading	Page
Mounting	2
Battery	2
Sleep Mode	3
External Connections	3
Display	4
Key Pad	4
Enter Key	5
Mode Selection	5
Unit Selection	6
Filter Selection	6
Power Tool Testing	7
Mountz Data Acquisition Add-In for Excel	8 - 10
EZ-terminal	10 - 14
- Changing Comm Port	12
- Setting Direction	12
- Updating Firmware	13
- Changing Languages	14
Calibration	15 - 17
Accessories	18

FEATURES OVERVIEW

- ❑ Accuracy +/- 0.5% of reading from 20% to 100% of full scale.
Accuracy +/- 1% of reading from 10% to 20% of full scale.
- ❑ Built-in transducer and easy to use menus.
- ❑ For all small hand tools & non impacting power tools.
- ❑ Selection of two operation modes: (Track, Peak).
- ❑ Four units of torque measurements: (lbf.in, cN.m, N.m, kgf.cm).
- ❑ Four low-pass filter selections (3000, 1500, 1000 and 500 Hz).
- ❑ Battery powered with up to 10 hours of operation.
- ❑ RS-232 interface to download readings in "real time."
- ❑ "Flash" memory allows upgrades to be done by the user in the field & internet through the RS232 port.
- ❑ Two methods of calibration are provided, a single point calibration (using a manual pot adjustment) and a multipoint calibration using **EZ Calibration**, a PC based Windows software program.
- ❑ Includes four rundown adapters and a selection of both American and Metric screws along with washers to allow a close simulation of actual joints.
- ❑ Includes **EZ Terminal**, for updating processor code and controlling torque direction to be displayed, **EZ Calibration** for multipoint calibrations, and **Data Acquisition Add-In** for Excel that allows for ease of collecting and analyzing data.

IMPORTANT PRECAUTIONS

The EZ-TorQ is solely designed for measuring and testing of torque controlled equipment such as wrenches, power tools or hand screwdrivers. Mountz, Inc. strongly recommends that this analyzer not be modified and/or used for any application other than for which it is designed.

MOUNTING

It is recommend securing the analyzer to a workbench before operating. Immobilizing the analyzer is critical for the safety of the operator as well as for the accuracy of torque measurements during operation.

Mounting the unit to a fixed surface offers the most secure way to immobilize the analyzer, and is recommended when used at a permanent location. It employs two spring loaded mounting screws from the unit into the mounting surface.

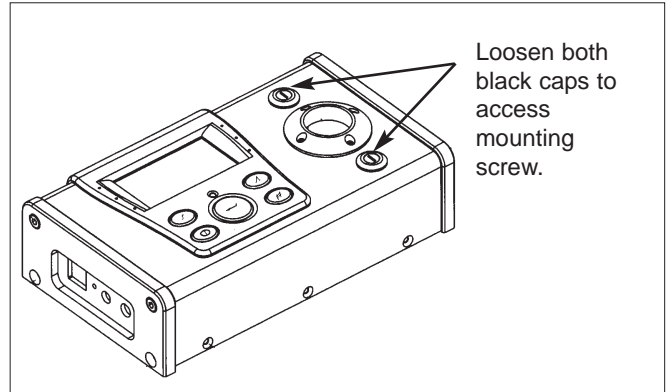

Note: Remember that a loose Analyzer during utilization can impact the validity of torque readings. Always make sure the unit is secure before operating, as repeated usage may loosen the screws.

BATTERY OPERATION

The EZ-TorQ Torque Tester is powered using NmH batteries for long battery life. The battery pack should last up to 10 hours with normal use and maximum charge. When the battery charge falls to a point where it requires a charge, a battery low icon will appear on the display as shown below.

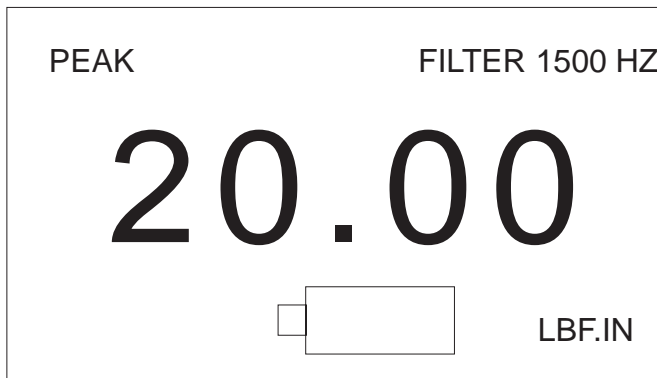

When the battery icon appears, the unit should be connected to the external AC adapter to charge the batteries. The torque readings may become inaccurate when the unit is used with a low battery. Charging time is 4 hours minimum, but the unit may be used while charging.

If the batteries become critically low, the unit will shut itself off.

Universal Charger/Adapter

The unit is supplied with a Universal Charger/Adapter. Slide the switch between 110V or 220V.

The adapter for the 100V plug slides on & off the 220V plug.

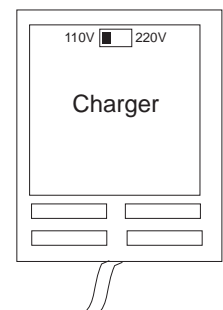
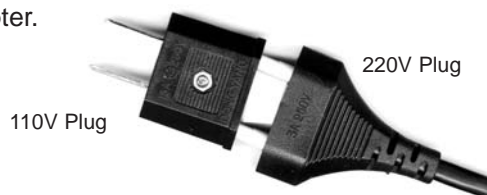

SLEEP MODE

If no torque operations are performed for 10 minutes, the unit will go into sleep mode to conserve battery life and display "SLEEP" on the display. Press any key to wake the unit from sleep mode.



EXTERNAL CONNECTIONS

On the left side, there are three slots for external connections.

External Power Supply

Plug the provided transformer to charge the internal batteries in the unit.

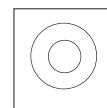

RS 232 Out Put

The RS 232 can be used for printing or downloading torque values into a computer or used with an external PC to calibrate the unit.

Rate: 9600 BPS

Format: 8 bits fixed, 1 stop bit, no parity.



RS 232 Connection Pin-Out

The following diagram and Table define the pins of the I/O connectors for the EZ-TorQ Torque Tester.

Pin Numbers
6.....

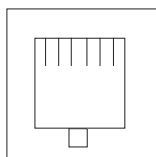

RS 232

RS 232 Connector

Pin	Signal
1	Not used
2	RXD
3	TXD
4	Not Used
5	Ground
6	Not Used



Analog Output

Connector provided for those that wish to monitor the amplified analog signal before the analog to digital conversion.



USER INTERFACE

DISPLAY

Two modes of operation for measuring torque (current setting displayed)

Current filter selection is displayed

Large Display of Torque Reading

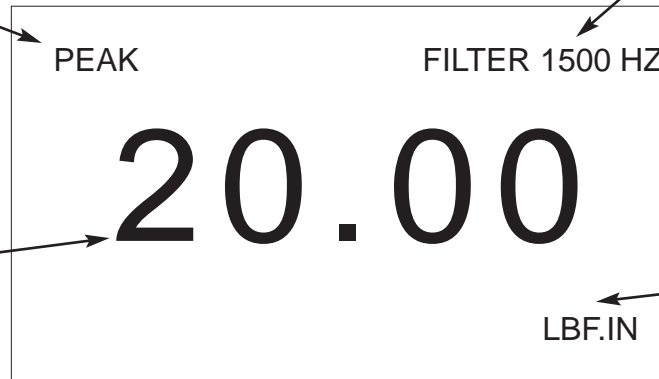

Select one of three measuring units (current units are displayed)

KEYPAD

"Filter" change key

"Mode" change key

Power ON/OFF

"Enter" Key to clear readings, lock in mode or units and send to RS232 port.

"Unit" change key

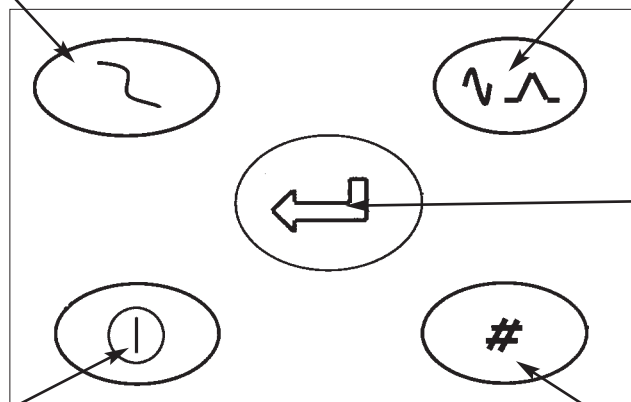

ENTER KEY

The ENTER key function is used for two functions.

CLEARING DISPLAY

The first function is used to clear any torque reading on the display. When the ENTER key is pressed it also sends the displayed reading to the RS 232 port for printing or downloading to an application program. After sending the data, the readings will automatically be cleared from the display.



VALIDATING SET-UPS

The other function is the validation of user selection during set-ups (see the Mode Selection, Filter Selection, and the Units Selection).

MODE SELECTION

The EZ-TorQ Torque Tester offers two different modes of displaying torque information during operation (Track and Peak). The user will determine which mode is best suited for the application. The use of the two modes is described below.

Key sequence to change mode:

- ❑ Press Mode  and the display will go blank except for the mode, which will be flashing on the display.
- ❑ Press Mode repeatedly until the Mode that is needed is displayed on the graphics display.
- ❑ Press Enter  to lock in the mode selected and go back to the display mode.

Flashing on display



TRACK

This mode constantly tracks increasing or decreasing torque variations. Use this mode to monitor varying torque on motors and machinery. Also for calibration and testing of dial torque products (small wrenches or dial screwdrivers).

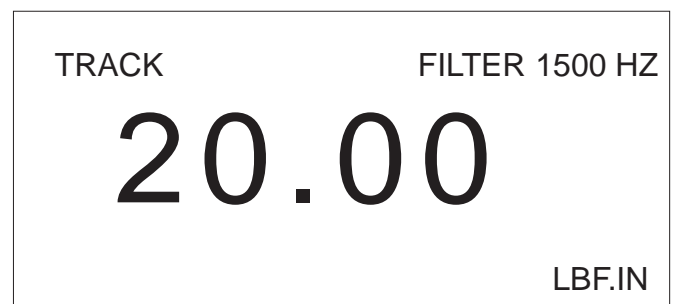

PEAK

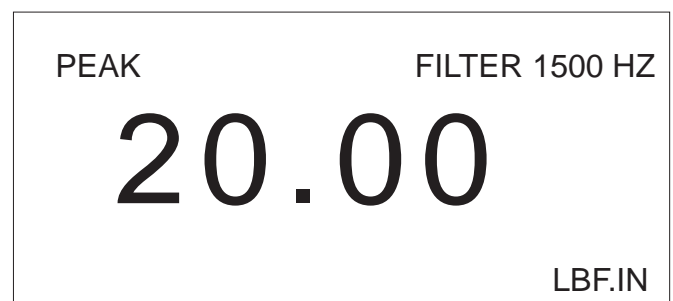

The display retains the highest torque applied. Use this mode during calibration or testing of any hand type torque wrench (dial, beam, and screwdriver), as well as power tools.



UNIT SELECTION

The EZ-TorQ Torque Tester supports four units of torque measurement, lbf.in, cN.m, N.m and kgf.cm.

The Key sequence to change units:

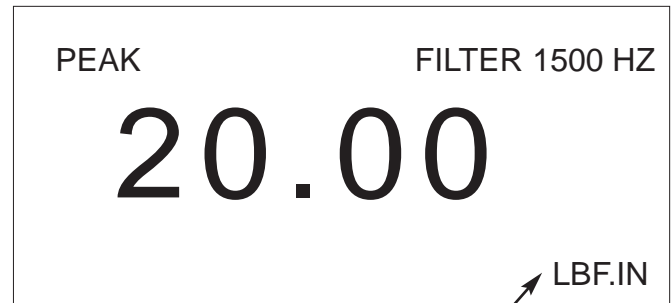

- ❑ Press Units  and the display will go blank except for the currently selected units which will be flashing on the display.
- ❑ Press Units repeatedly until the Units selection that is needed is displayed on the display.
- ❑ Press  Enter to lock in the Units and to go back to the display mode.



FILTER SELECTION

The EZ-TorQ Torque Tester supports four low pass filter selections (500, 1500, 2000 and 3000 Hz).

The Key sequence to change the filter is:

- ❑ Press Filter  and the display will go blank except for the currently selected filter which will be flashing on the display.
- ❑ Press Filter repeatedly until the Filter selection that is needed is displayed on the display.
- ❑ Press Enter  to lock in the Filter and to go back to the display mode.

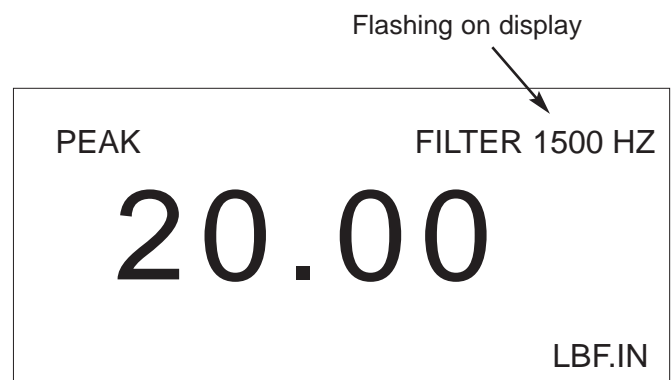

The process of converting dynamic mechanical torque to an electronic signal, using a transducer, may result in unwanted noise. This results in a distorted signal and thus an erroneous torque value. As the signal is made up of a number of frequencies, it is possible through the use of appropriate circuitry to selectively filter out some or all of the unwanted noise.

If a joint is hard, the tool pulses very fast, or has a “hard” shut off; the fastening operation may result in electronic noise and “ringing”. Noise and ringing may be picked up by the electronics receiving a signal from the transducer. This noise and ringing result in torque readings, which are not the same as the actual torque applied to the fastener.

A filter allows the unwanted signals to be “filtered” from the electronic signal. Typically a filter of 1500 Hz works well for most tools and joints. If you find that reading as consistently high, or you get occasional peaks that are high, compared to the actual application torque, you may be reading noise. If this is the case, try lowering the filter value. No single filter value can be specified for every application. This is a trial and error process, as joints and various dynamic tools, will have different characteristics.

POWER TOOL TESTING

The run down adapters (RDA) are designed to provide consistent and reliable torque readings for use with power driven torque control tools. The RDA's reduce the impact and irregular peaks that cause poor repeatability. Each RDA has an effective torque range and will supply repeatable torque data within that range if used correctly.

Always use a quality joint rate simulator (run down adapter) when testing power tools in a simulated application. Use the peak mode. The Peak mode is designed to meet the demanding frequency requirements for testing dynamic torque applications.

Using Run Down Adapters

The EZ-TorQ includes a 1/4 Female Hex Square Drive Adapter which is used for test hand tools. It also includes a Run Down Adapter

Operation

1. The run down adapter is placed in-line between the tool drive and transducer of the torque tester.
2. The torque tester should be properly secured on a solid surface or a test bench.
3. Before each test run, the Input drive run down adapter (RDA) should be completely backed-up. (Unless using Mountz AURA run down adapter)
4. The RDA is designed to run in clockwise direction only.
5. Apply torque until RDA is run down completely. Then note or save reading with the torque tester.



MOUNTZ DATA ACQUISITION ADD-IN FOR EXCEL

This is a utility program provided by Mountz, Inc. for allowing data from the EZ-TorQ, TorqueLab® or the TorqueMate® to be imported directly from the RS232 port on your computer into an Excel spreadsheet. This utility is extremely easy to install and use.

INSTALLATION

Insert the CD that was included with the EZ-TorQ analyzer into the CD drive. The installation will automatically start. Just respond to a couple of questions and the program will be installed on your computer.

OPERATION

Once the utility is installed on the computer, you need to enable its use in Excel. Simply choose "Tools" and then "Add-In" as shown on the right.

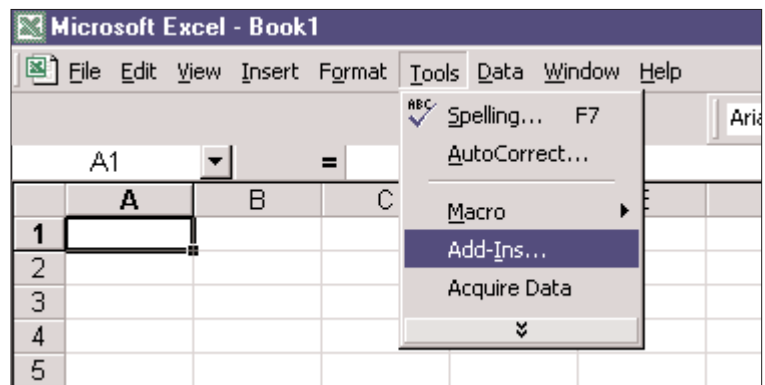

After clicking on "Add-Ins", you will see a list of available Add-Ins for Excel as shown. Just check the box next to Mountz Data Acquisition Add-In to make it available within Excel.

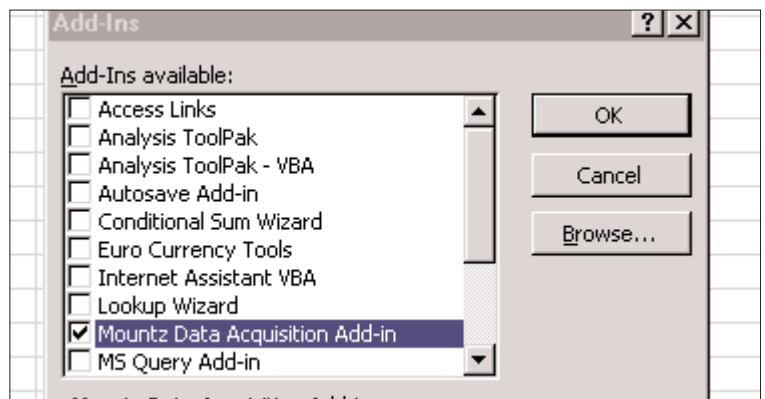

Note for Microsoft Upgrade Users

After installation of the Mountz Data Acquisition Add-In software (the installation was successful) and you don't see the "Mountz Data Acquisition Add-In" in the Add-In list when you are in Excel, please read and follow these steps.

This anomaly may occur if you are operating with upgraded version of MS Office. After an upgrade, you have two folders for MS Office (like Office and Office10) in the Microsoft Office folder. The installation program found the Office folder and placed it there in the Library folder.

If you encounter this, you should locate the file (MTZData.xla) in C:\Program Files \ Microsoft Office \ Office \ Library. You need to move it to C:\Program Files \ Microsoft Office \ Office10 \Library.

The Add-In will now appear in the Add-In list in Excel and you can check the box and use it.

Now that the Add-In is enabled, you can start it at any time by clicking on "Tools" and then clicking "Acquire Data".

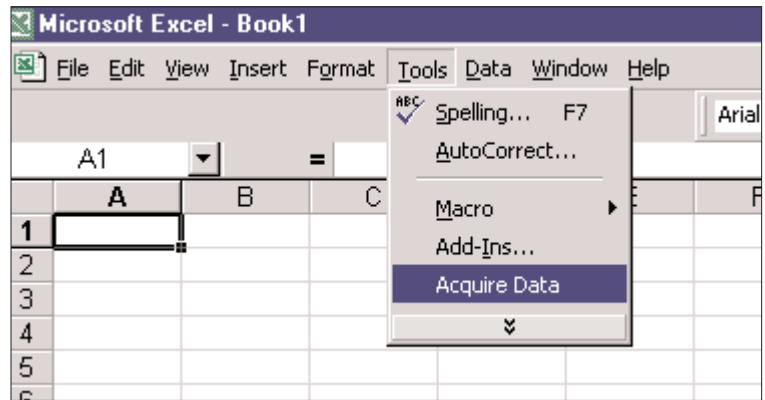

A Window will pop up within Excel that allows you to select the Communications Port and the type of Torque Analyzer that you are collecting data from.

Select your Communications Port and the Analyzer used and then click on "Start Capture". Readings from the analyzer will be inserted in the Excel Spreadsheet. When you are finished collecting data, click on "Stop Capture".

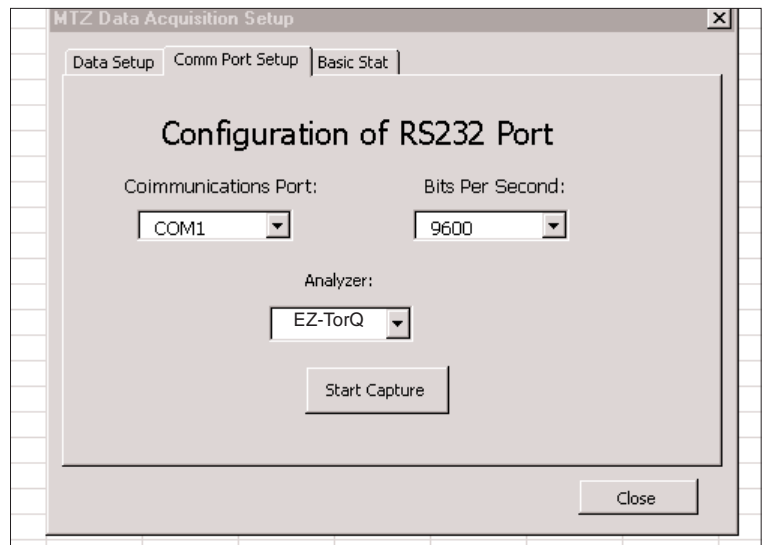

You will notice that the default of this utility will place the data in Sheet 1, Column A, starting in Row 1 and place the data in columns. If you wish to place the data into the spreadsheet in another configuration, then click on the Data Setup Tab and you can setup the configuration differently.

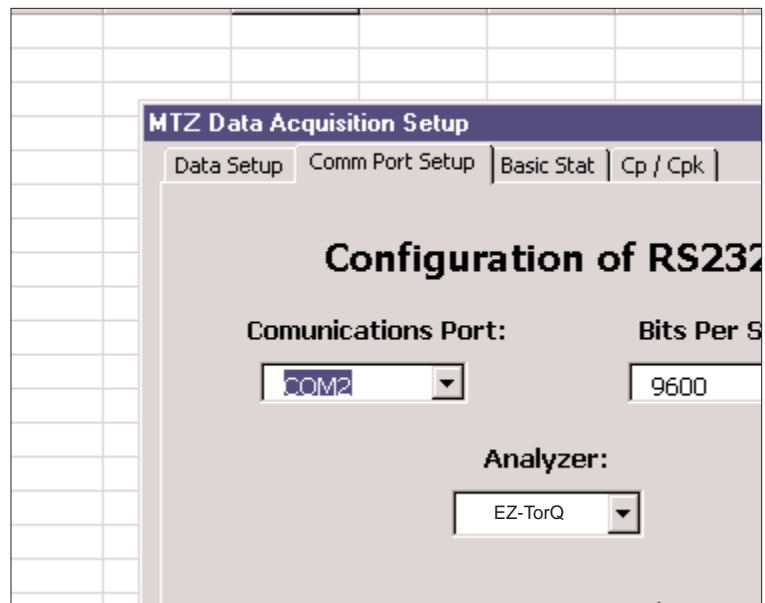

This utility can be used to perform some simple statistics on the data that was collected in the spreadsheet. Just click the "Basic Stat" Tab .

All the data, that was captured, will be highlighted. If you wish to edit the data, before running statistics, then you must "Close" the Data Acquisition Window and edit your data. Then highlight the data that you wish to analyze, and start the utility again. Choose the Basic Stat Tab and click on "Calculate". Basic statistics will be calculated and inserted in the Excel spreadsheet.

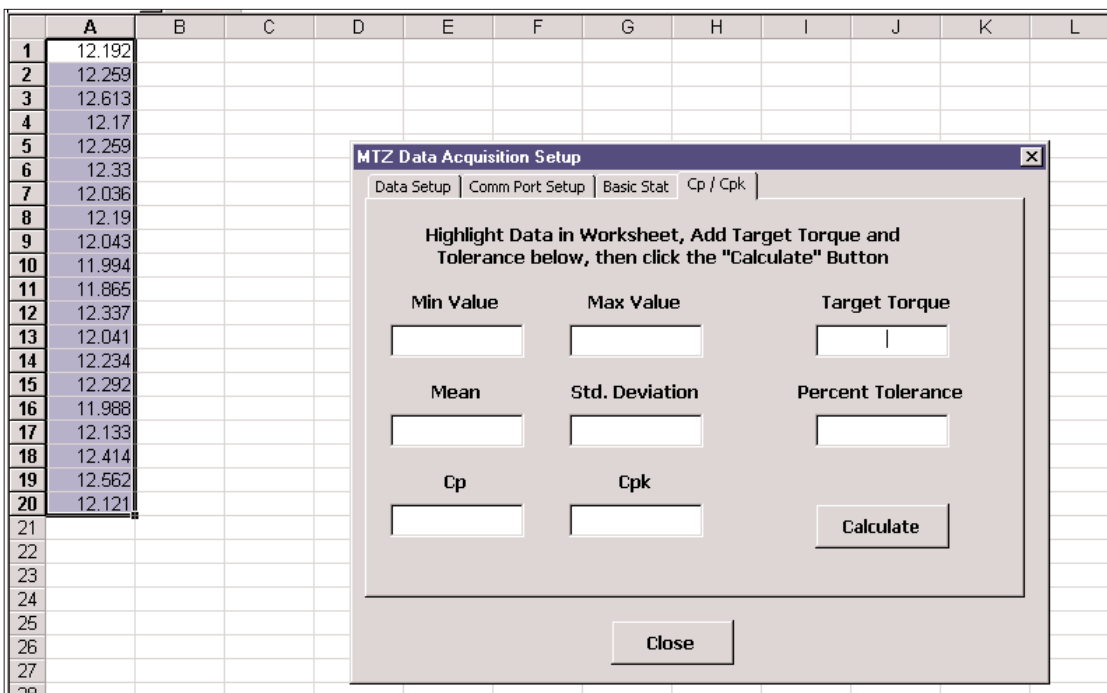
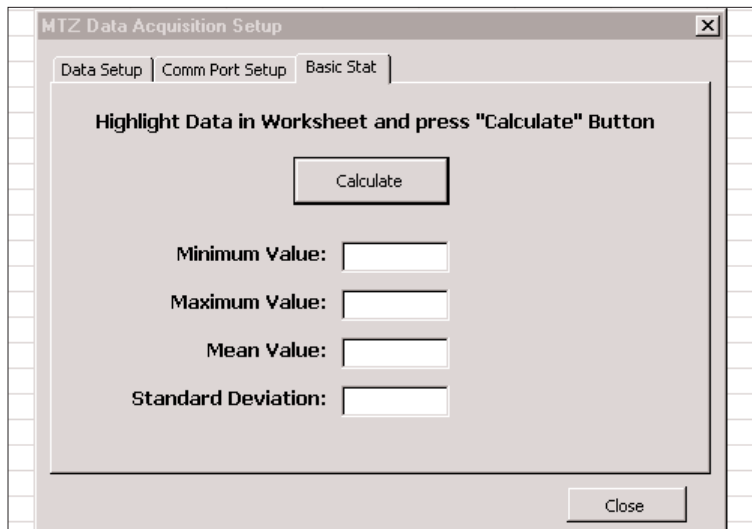

Lastly, this utility can be used to perform more sophisticated statistics on the data that was collected in the spreadsheet. For this you will need to enter the "Target Torque" and the "Percent Accuracy" for the readings. Click the "Cp / Cpk" Tab and you will see the window as shown above.

All the data, that was captured, will be highlighted as shown above. If you wish to edit the data, before running statistics, then you must "Close" the Data Acquisition Window and edit your data. Then highlight the data that you wish to analyze, and start the utility again. Choose the "Cp / Cpk" Tab, enter values for the Target Torque and Percent Tolerance and click on "Calculate". The statistical values will be calculated, displayed in the window and inserted in the Excel spreadsheet.

EZ TERMINAL

This program is a Windows based application supplied as a utility to your EZ-TorQ analyzer. This utility for the EZ-TorQ allows four functions to be performed.

One function allows the firmware that controls the analyzer to be updated. This is possible because the product uses a processor with a flash memory and boot code to allow upgrades of the firmware. For future enhancements and upgrades of the EZ-TorQ watch for any upgrades on the Mountz website.

The second function allows the EZ-TorQ to be configured to display torque in only one direction. The default setting is to display torque in both clockwise and counterclockwise directions. This function is useful if you wish to do repeated run-downs and collect the data using the Data Acquisition Add-In to Excel that is provided with the product. After a rundown you press Enter to clear the reading and send the data to Excel. After the rundown you can back out the fastener without displaying a reading.

The third function allows changing of the communications port used for RS232 communication and fourth function is changing operating languages.

INSTALLATION

To install the EZ Terminal program on your computer do the following:

1. Insert the EZ-TorQ CD into your CD drive.
2. The Data Acquisition Software will begin to install. If you have previously installed it just click the Cancel button.
3. Click the Start button and select Run.
4. Click Browse and choose your CD drive.
5. Double click on the EZ Terminal folder.
6. When the folder opens click on Setup.exe.
7. Click on Open.
8. Click OK. The installation program will begin the installation.

OPERATION

Make sure the EZ-TorQ is powered down. When you start this program you will first be asked to choose the function. Click on the Combo Box, where it says function, and choose the desired function. Connect the EZ-TorQ to the RS232 port on the computer running the software using the supplied cable. Power up the EZ-TorQ and while "Please Wait" is displayed click the "Send" button in EZ Terminal. The Text box will guide you with the steps to be performed. The steps are further outline below depending on the function to be performed.

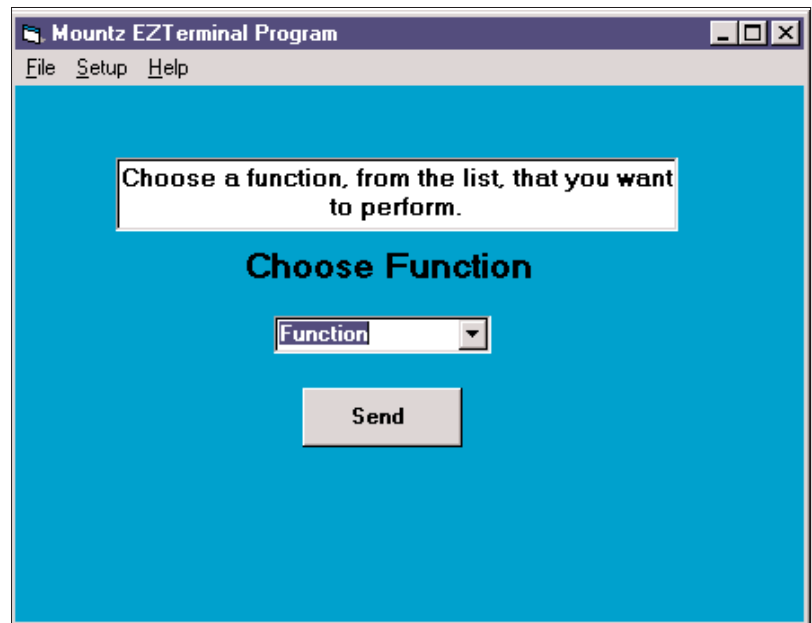

CHANGING THE COMM PORT

EZ Terminal uses the RS232 port to communicate with the EZ-TorQ unit. The default setting for the Communications Port is Comm 2. A different Comm port may need to be used on your computer. EZ Terminal should warn you that the current Comm port is not available. To change the Comm Port, click "Setup". Then click "Comm Port" and choose the required Comm Port from the list and then click "Set". The selected communications port will now be used and stored in the Windows Registry so you don't need not configure this again.

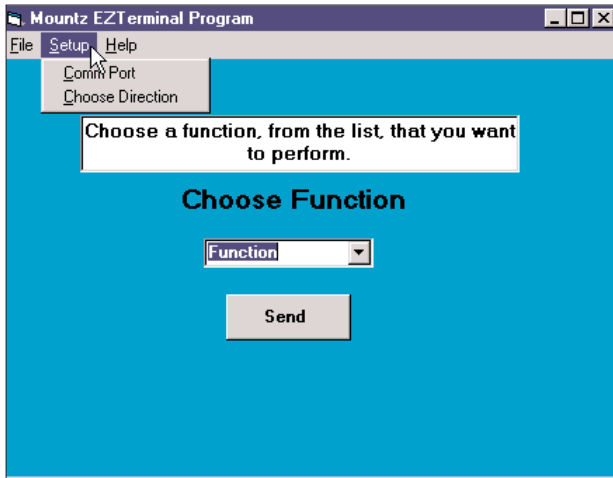

SETTING DIRECTION

Start the EZ Terminal program and choose the function "Set Direction".

Power up the EZ-TorQ and while "Please Wait" is displayed click the "Send" button in EZ Terminal. EZ-TorQ will now display "SETTING DIRECTION". Choose "Setup" and then click "Choose Direction". Click on the Combo Box, where it says Direction, and choose the desired direction.

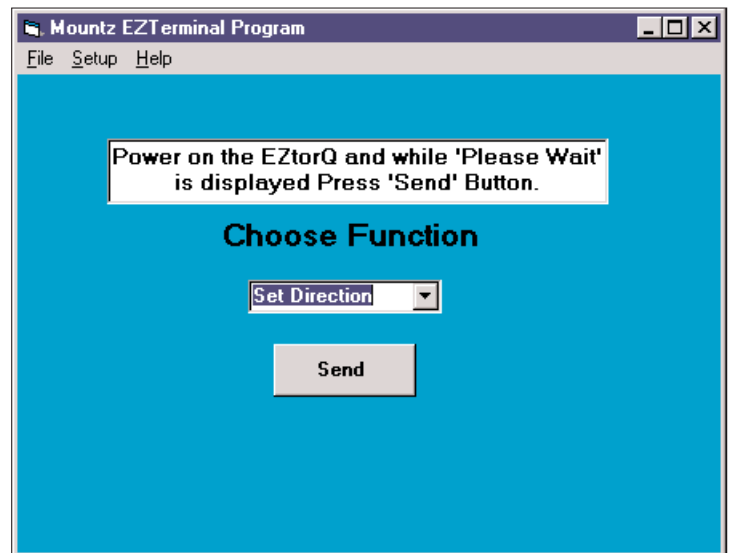

Note: Before performing a Deadweight calibration, you must use EZ Terminal to set the direction back to "Both".

UPDATING FIRMWARE

Make sure you have loaded the EZ_VerX-X.hex file on the computer running EZ Terminal. Start the EZ Terminal program and choose the function "Update Firmware".

Power up the EZ-TorQ and while "Please Wait" is displayed click the "Send" button in EZ Terminal. The EZ-TorQ should now display UPDATING FIRMWARE on the display. Click "File" and then click "Send Hex File". The Common Dialog box will allow you to select the drive and location of the EZ_VerX-X.hex update file. Once you find this, click the "Open" button to start the download. The upgrade should only require about 1 minute and the EZ-TorQ unit will start itself again after the upgrade. EZ Terminal will also inform you that the download is complete.

*** Caution ***

Do not shut down the Terminal Program when it is in the process of updating the firmware! Doing so may result in critical sections of code to be missing making your analyzer non functional. If this happens you will have to return your EZ-TorQ unit to the factory to have the firmware restored.

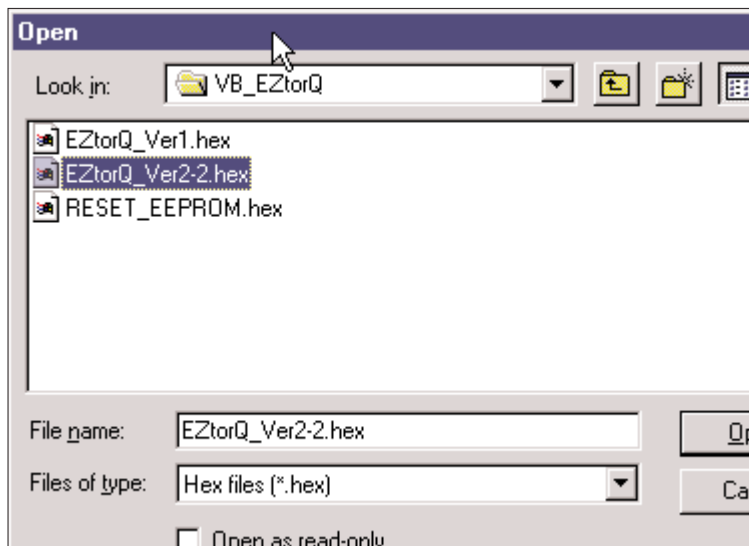
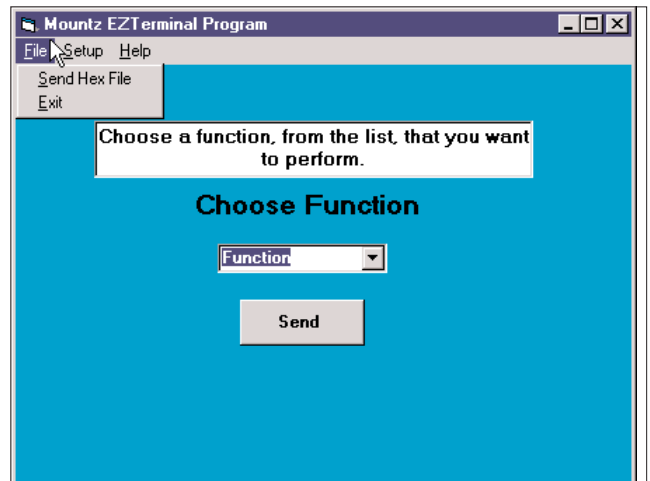
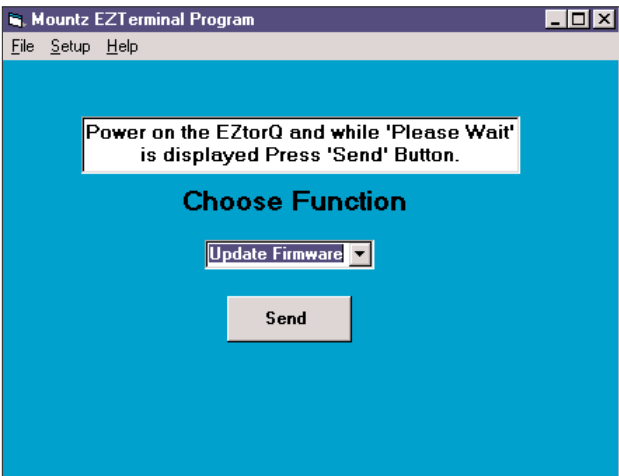

CHANGING THE LANGUAGE OF THE EZ-TorQ DISPLAY

EZ-TorQ models with software version 5.0 or after

Please note that Version 5.0 now has all Languages available in the EZ-TorQ. You do not need to connect to the Application software to change the Language. Options are Chinese, English, French, German, Italian and Spanish.

In order to change the Language perform the following steps:

1. Turn on the EZ-TorQ unit and wait for initialization to complete.
2. Press the Filter Key and within 3/4 second press the Mode Key.
3. The display will flash ENGLISH on the display.
4. Press the Mode Key until you find the Language desired.
5. Press the Enter Key twice and the unit will now have the desired Language.

The EZ-TorQ unit will now remember the Language selected when powered down.

EZ-TorQ models with software version 3.9 or prior

The language of the EZ-TorQ display can be changed. Language options are Chinese, English, French, German, Italian and Spanish. Contact Mountz to receive the language file.

The language file needs to be uploaded to the EZ-TorQ. In order to change the language, follow the procedure of Updating Firmware in the EZ-Terminal section (page 14). After choosing "Send Hex File", locate the appropriate hex file for the language of choice and click "Open". The firmware will be changed to the language of choice.

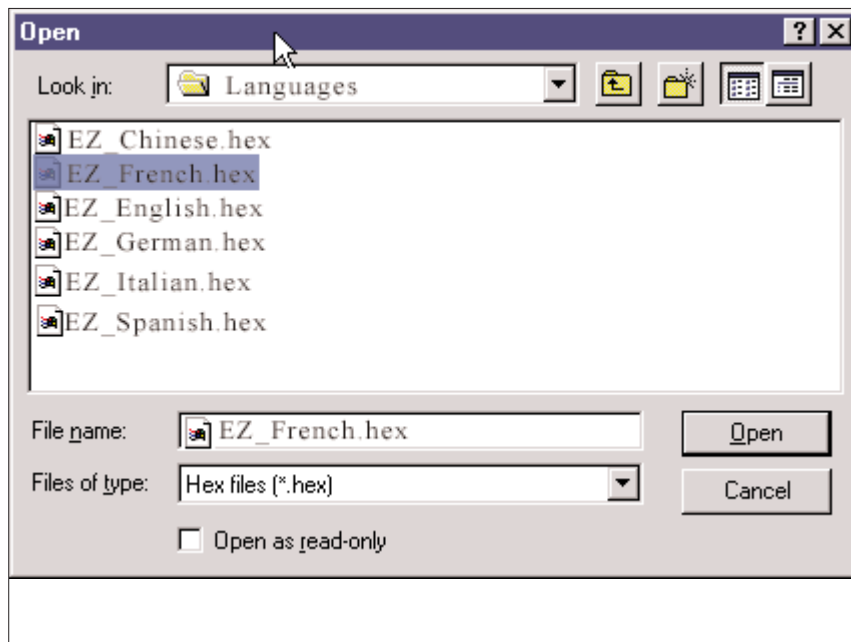

Image is EZ-TorQ models with software version 3.9 or prior

EZ CALIBRATION

This program is a Windows based application supplied as a utility to your EZ-TorQ analyzer. This tool provides a Windows based application to perform a 4 point calibration (in each direction). The calibration points include 0, 10%, 50% and 100% in each direction. Calibration is the only function performed by this program except for the ability to change the communications port used for RS232 communication. (See EZ Terminal page 13 for setting the Comm Port, it works the same way.)

INSTALLATION

To install the EZ Calibration program on your computer do the following:

1. Insert the EZ-TorQ CD into your CD drive.
2. The Data Acquisition Software will begin to install. If you have previously installed it just click the Cancel button.
3. Click the Start button and select Run.
4. Click Browse and choose your CD drive.
5. Double click on the EZ Calibration folder.
6. When the folder opens click on Setup.exe.
7. Click on Open.
8. Click OK. The installation program will begin the installation.

CAUTION! Do not run this program without the proper calibration wheels and weights to perform a complete deadweight calibration. To do so will cause your calibration data to be overwritten.

OPERATION

When you start the EZ Calibration program it will open a new Window "Calibration Mode". The small Text box will guide you through the required steps. Analog to Digital (A/D) counts will be displayed in the large Text box.

It is recommended to hang full scale weights in both directions and adjust the gain pot (accessible through a hole on the side of the EZ-TorQ unit near the connectors) so that the side that gives the maximum counts are around 7500 counts. As the maximum A/D counts are 8192 this will allow for displaying approximately 8% over torque. For example the 100 lbf.in unit will be able to display up to 108 lbf.in.

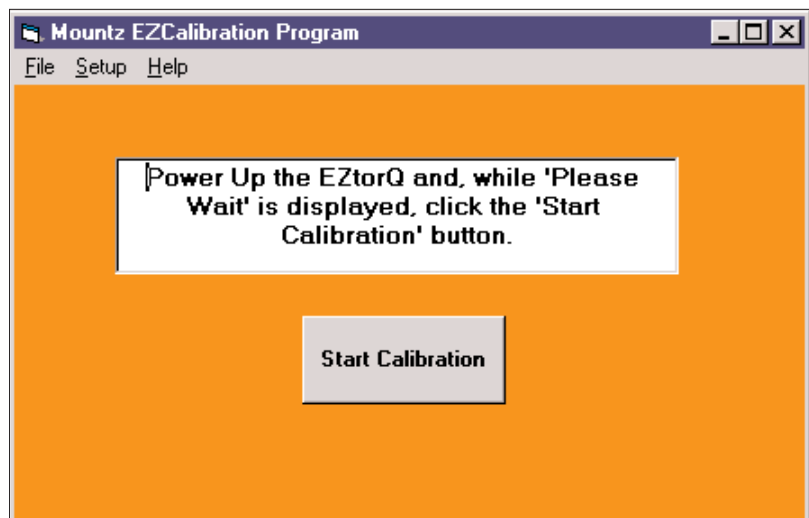

“TRUE DEAD WEIGHT” CALIBRATION METHOD

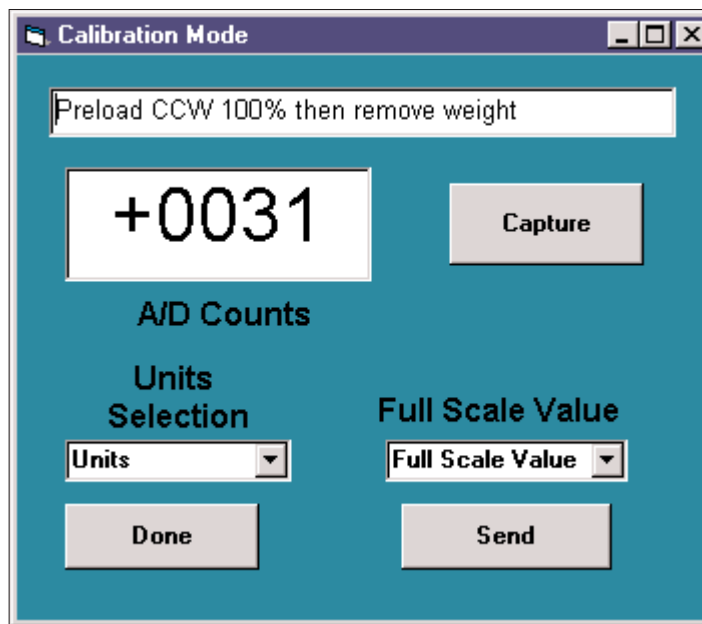

The small Text box will guide you through the calibration steps but this will be outlined below.

1. Hang 100% counter clockwise (CCW) and remove the weights. When the A/D reading stabilizes click on "Capture".
2. Hang 10% CCW and wait for the A/D reading to stabilize and click on "Capture".
3. Hang 50% CCW and wait for the A/D reading to stabilize and click on "Capture".
4. Hang 100% CCW and wait for the A/D reading to stabilize and click on "Capture".
5. Hang 100% clockwise (CW) and remove the weights. When the A/D reading stabilizes click on "Capture".
6. Hang 10% CW and wait for the A/D reading to stabilize and click on "Capture".
7. Hang 50% CW and wait for the A/D reading to stabilize and click on "Capture".
8. Hang 100% CW and wait for the A/D reading to stabilize and click on "Capture".
9. Choose the Calibrated Set of Units using the list box for this purpose and then choose the Full Scale value using the list box for this purpose.
10. Click the "Done" button. The EZ Calibration software will do a "Least Squares Curve" fit to the data captured.
11. Press "Enter" on the EZ-TorQ to alert it that the calibration data will be sent and then click "Send" to send the calibration data to the EZ-TorQ.
12. The EZ-TorQ will start up again and use the calibration data to display torque values. EZ Calibration will inform you that the calibration is complete.
13. You can now hang weights at any number of points to verify that the calibration is within specification and generate your report.
14. EZ Calibration can be left running while you verify the calibration points. It will display the torque applied at each point for your convenience

“QUICK, SINGLE POINT” - CALIBRATION METHOD

A "True", Deadweight calibration requires a weight set to apply 10%, 50% and 100% of full scale in each direction. These weights would be used with the EZ Calibration Software. If you do not have the appropriate weights to do a True calibration you can perform a Quick, single point calibration.

Requirements

A calibration wheel, of the correct size, for applying torque is needed. Also the appropriate weight to apply 100% torque for the EZ-TorQ analyzer.

Procedure

Make sure no torque is applied to the transducer when you power up the EZ-TorQ unit. This is important, as the unit will determine the offset of the transducer when it powers up.

1. Simultaneously press the "Mode" and "Units" buttons.
2. While the "Mode" flashing, press the "Units" key.
3. The display will indicate MAX TRQ xx.xx where the xx.xx will be some numerical value.
4. Use the "Mode" key to change the digit and the "Units" key to move to a different digit.
5. Set the MAX TRQ value to an appropriate value for the EZ-TorQ unit. For example 100.0, 50.00 or 10.00. Do not worry about the decimal point it comes later.
6. After all numeric digits are correct press the "Enter" key.
7. The display will now indicate DEC POS.
8. Use the "Units" key to move the decimal point until it is in the correct position.
9. Press "Enter".
10. The display will go through an initialization and the Torque value should read zero.
11. Securely mount the EZ-TorQ unit.
12. Insert the calibration wheel.
13. Hang the required weight to apply Clockwise Torque at 100%.
14. Adjust the gain pot (accessible through a hole on the side of the EZ-TorQ unit near the connectors) so that the Torque reading displayed on the EZ-TorQ is the maximum value for the EZ-TorQ.
15. The "Quick" calibration is now complete.

CALIBRATION KITS

Mountz offers calibrations kits for calibrating the EZ-TorQ. The kit includes a wheel, hangar & weights.

Item #	Model
061279	Calibration Kit for EZ-TorQ 10i (American)
061280	Calibration Kit for EZ-TorQ 50i & 100i (American)
061282	Calibration Kit for EZ-TorQ 10i (Metric 11.5 kg)
061283	Calibration Kit for EZ-TorQ 50i & 100i (Metric 57.5 & 115 kg)
061236	Bracket for Mounting EZ-TorQ*

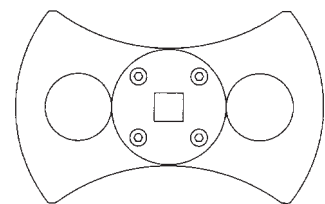

ACCESSORIES

Model	Item #
Charger (for EZ-TorQ)	770055
Case (for EZ-TorQ)	600729
Battery Pack (for EZ-TorQ)	708003
Battery Pack (for EZ-TorQ)*	061996
Brush Cap	14-501830
RS232 Cable	773855
1/4 F/Hex Sq. Dr Adapter (17mm F/Hex)	600727

* Battery pack only for EZ-TorQ models that belong to the following serial number range: EZ20401001 - EZ2040110

** Rundown Adapters Kit includes : four rundown adapters & 1/4 Female Hex Square Drive Adapter.

Service

Mountz Inc. features an experienced calibration and repair staff. Our trained technicians can calibrate and repair most any tool. Mountz provides rapid service with quality that you can trust as we offer three state-of-the-art calibration lab and repair facilities that can calibrate up to 20,000 lbf.ft.

With over 40 years of experience, Mountz's in-depth knowledge of torque is reflected in our tool's craftsmanship and our ability to provide solutions to both common and uncommon torque applications. We perform calibrations in accordance with ANSI/NCSL-Z540. Mountz is dedicated solely to the manufacturing, marketing and servicing of high quality torque tools.

Tool Service & Repair Capability

Torque Wrenches: Click, Dial, Beam, Cam-Over & Break-Over

Torque Screwdrivers: Dial, Micrometer, Preset & Adjustable

Torque Analyzers/Sensors: All brands

Electric Screwdrivers: All brands

Air Tools: All brands

Impact Wrenches, Drills, Pulse Tools, Grinders, Percussive Tools,
Air Screwdrivers, Nutrunners, DC Controlled Nutrunners

Torque Multipliers: All brands

Mountz Service Locations

Eastern Service Center

19051 Underwood Rd.
Foley, AL 36535
Phone: (251) 943-4125
Fax: (251) 943-4979

Western Service Center

1080 N.11th Street
San Jose, CA 95112
Phone: (408) 292-2214
Fax: (408) 292-2733

Mexico Service Center

Mountz Mexico SA de CV Chihuahua
Av. Cristobal Colon #15343
Col. Paseos de Chihuahua
Chihuahua, Chih. Mexico CP 31125
Phone: (614) 481-0023
Fax: (614) 481-0053

www.eturque.com

Download a "Service Form" and include a copy
when you send the tools in to be serviced.