

Scout (Screw Counter) v 2.0 Operating Instructions

(Rev 2.0 10/10/11)

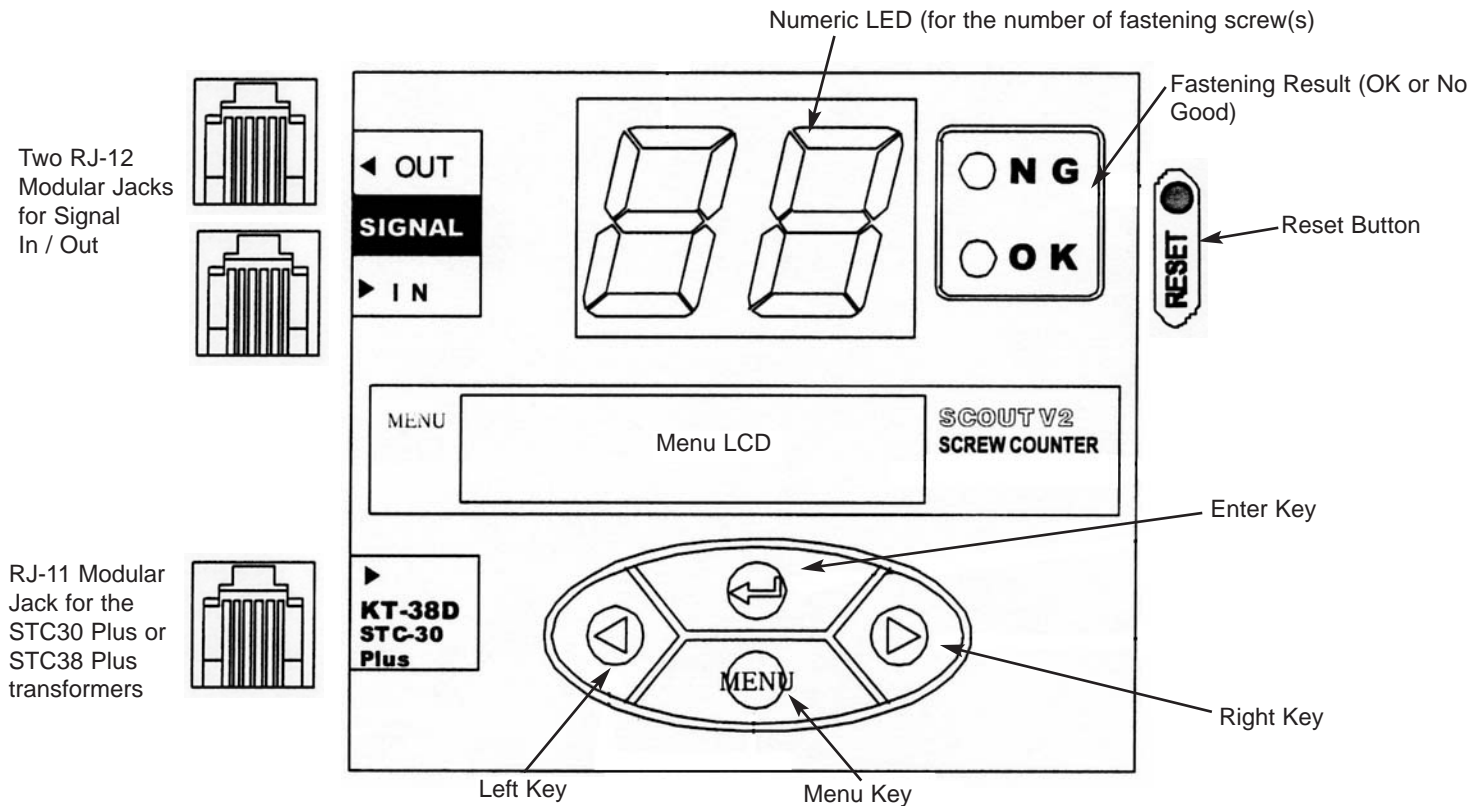

Scout Face Plate

1. The Scout can only be turned on when plugged into the STC30 Plus or STC38 Plus transformer.
2. To power up the Scout, plug in the cable to the STC30 Plus or STC38 Plus transformer where it says "Signal". Then plug the "Connection" cable into the RJ-11 modular jack where it says "STC30 Plus & KT38D." Make sure the transformer is plugged in too.
3. The "Cycle In & Out" RJ-12 modular jacks and the open-end cable are for connecting the Scout to a PLC, switch, sensor or other source.
4. The "Cycle" count can be started by the signal from a PLC, switch, sensors or other equipment. The Scout also sends the cycle-end signal to PLC or other equipment.
5. Numeric LED shows the number of screws that are fastened for a cycle (Max. 99).
6. Left Key is used for moving the cursor:
 - To the right direction in the Parameter set up mode
 - Decreasing counted Number in Operation Mode
 - Canceling the latest fastening time measurement in Fastening Time Measurement Mode
7. Right Key is used for moving:
 - Value up in Parameter set up mode
 - Increasing counted Number in Operation Mode
 - Clearing the current data in Fastening Time Measurement Mode
8. Menu Key is used for moving to the next menu.
9. Enter Key is used for saving the data.
10. All set up Menus can be accessed on the Menu LCD display.
11. Fastening results are displayed by NG or OK on every fastening. For the judgement of NG or OK, the tolerance setting can be set on the Parameter Set Up Mode.
12. Any failure of the units need the reset for clearing the problem.

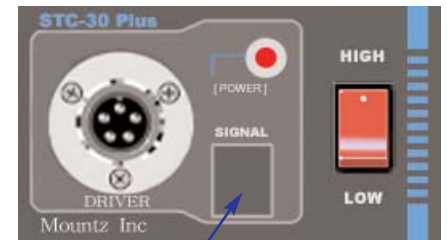

Plug cable from Scout into transformer

Scout (Screw Counter) v 2.0 Operating Instructions

(Rev 2.0 10/10/11)

Interface (Input)

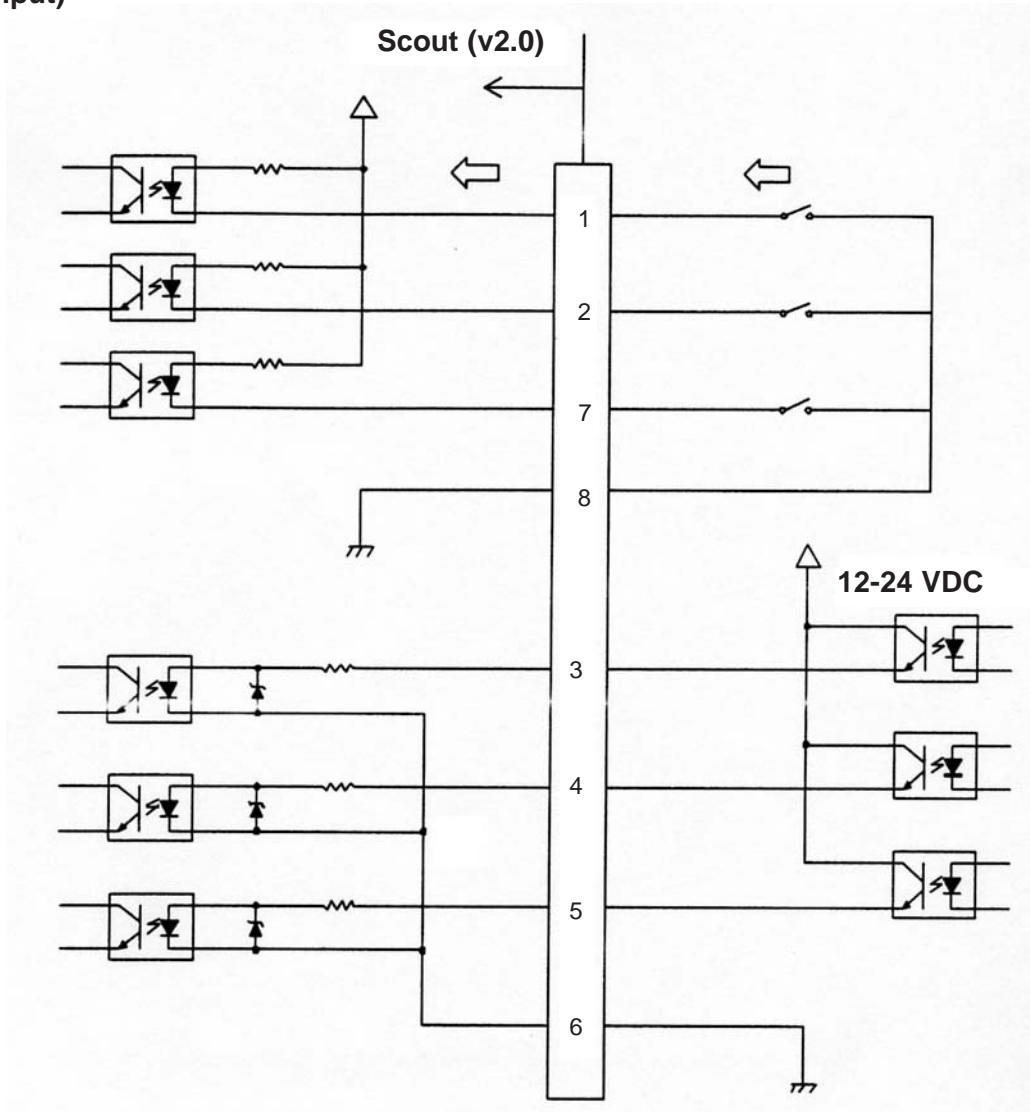

Pin No.	Color	Description
1	Orange	Cycle Start type 1 (see page 14)
2	White/Orange	Cycle Start type 2 (see page 14)
3	Blue	Cycle Start type 3 (see page 15) (IN)
4	White/Blue	Cycle Start type 3 (see page 15) (OUT)
5	Green	Cycle Start type 4 (see page 15)
6	White/Green	Common for Pin no. 3, 4, 5
7	Brown	Screwdriver Lock
8	White/Brown	Common for Pin no. 1, 2, 7

Scout (Screw Counter) v 2.0 Operating Instructions

(Rev 2.0 10/10/11)

Interface (Output)

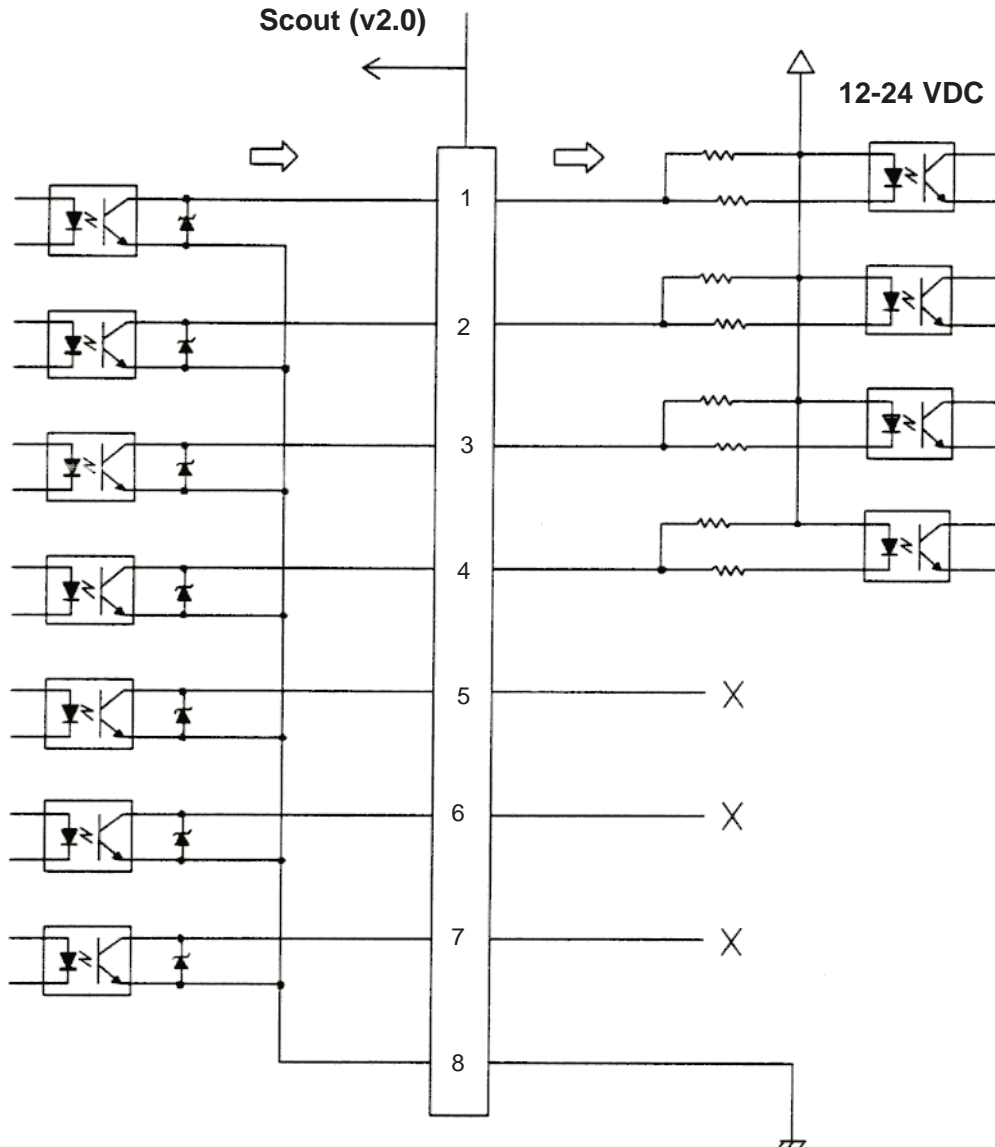

Pin No.	Color	Description
1	Orange	Cycle End
2	White/Orange	NG
3	Blue	OK
4	White/Blue	Buzzer
5	Green	Spare
6	White/Green	Spare
7	Brown	Spare
8	White/Brown	Common (-)

Note: Maximum current on Pin 1, 2, 3 and 4 should not exceed 5 mA.

Scout (Screw Counter) v 2.0 Operating Instructions

(Rev 2.0 10/10/11)

Timing Chart (example: number of fastening screw was set to three)

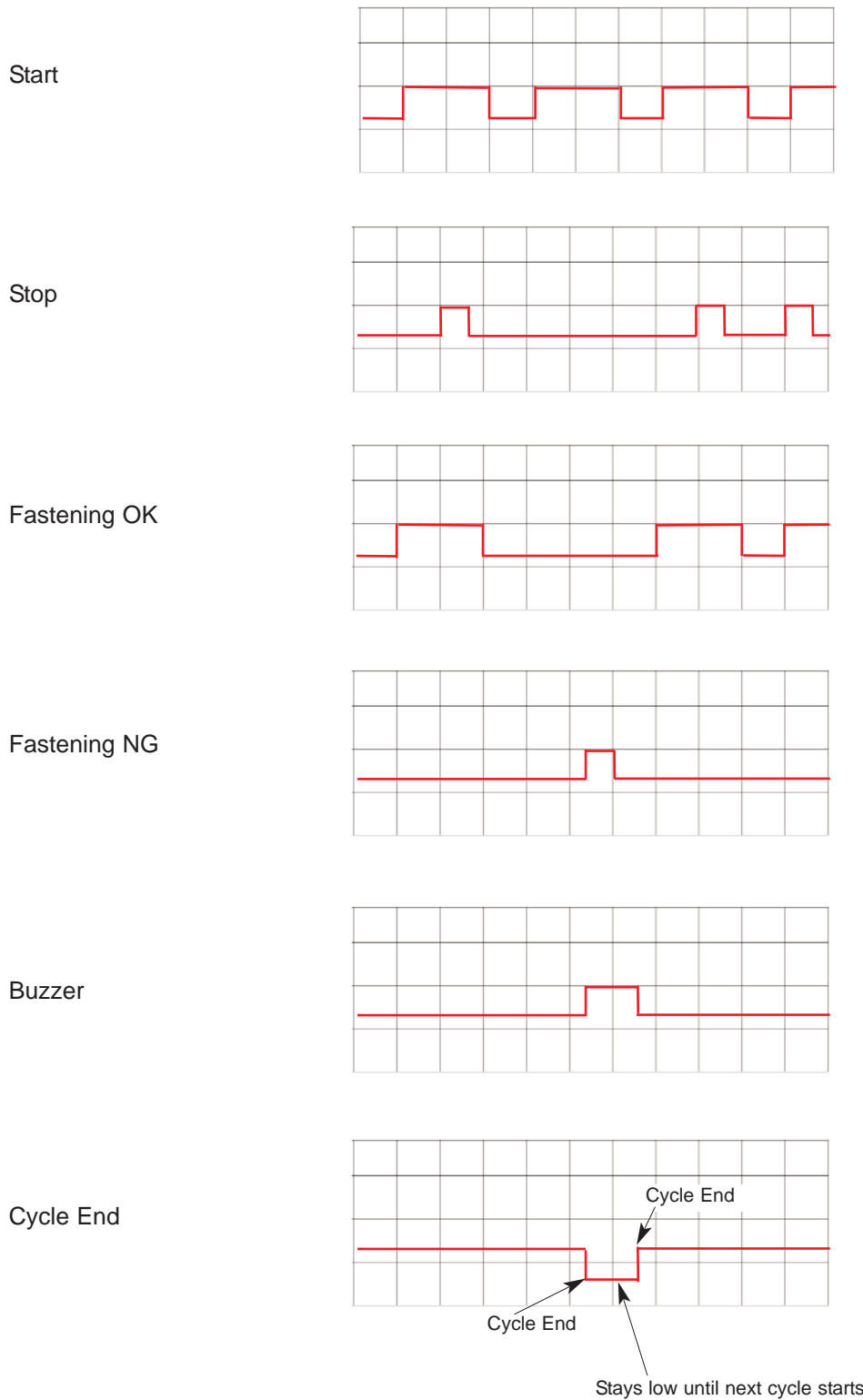

Scout (Screw Counter) v 2.0 Operating Instructions



(Rev 2.0 10/10/11)

Menu Composition

No.	Menu	Function
1	Operation Mode	Work Mode: Current Parameter Setting, Total Screws Fastened, Judgement (OK or NG) & Fastening Time (of last rundown)
2	Password	Security by entering pass word (initial password 0000)
3	Parameter setting	Program setting, Min & Max fastening time, Screw number
4	Cycle Start Setting	Start the cycle count
5	Fastening time test	Time Measurement of fastening the screw. Check Average and Min & Max value
6	Total Count Reset	Reset / Save Total screws fastened (Max. 9999999)
7	Buzzer Setting	Screw OK (Sound & Repeat) Screw NG (Sound & Repeat) Cycle OK (Sound & Repeat) Cycle NG (Sound & Repeat)
8	Output Signal Setting	Output Signal (100ms, 200ms, 300ms 500ms or 1sec.) Output Signal Act (Active High or Active Low)

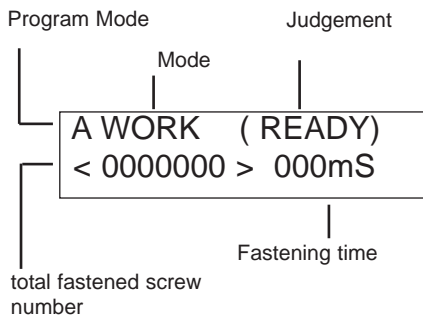
Operation Mode (Work Mode)



-  Adjust count "-1"
-  Adjust count "+1"
-  Total count number save

Example (OK fastening)

```
A WORK ( O K )
< 0000001 > 980mS
```

Example (NG fastening)

```
A WORK ( ERROR )
TIME LAPSE 740mS
```

1. Program Mode: Total of 7 different types of parameter settings can be stored in the Scout's memory (from A to G).
2. Mode: The current parameter setting that the Scout is operating from.
3. Judgement: Status of every screw being fastened (Displays OK or NG)
4. Total fastened screw(s): It is increased one by one after every OK fastening.
5. Fastening time: the measured time of each fastening.

Saving the Cycle Count Data

1. If you shut off the Scout unit before saving the total number of fastened screw(s), the data will be gone the next time you turn on the unit. If you toggle through different Menus after you performed some rundowns, you will lose the Cycle Count Data.
2. Press the Enter Key  at any time to save the Cycle Count Data. Before you toggle through any Mode, be sure to save your Cycle Count Data. Before you unplug the unit, be sure to save the Cycle Count Data.

Scout (Screw Counter) v 2.0 Operating Instructions

(Rev 2.0 10/10/11)

Operation Mode (Work Mode) Continued



Before running down the fastener, make sure you have selected the correct parameter setting (A - G) for the application. If you have not set up the tolerances for the fastening application within any parameter setting, then go to the Parameter Set Up Mode on page (6).

Proper Fastening - "OK"

After every completed fastener rundown within the tolerance setting, the Scout's screen will display "OK" with the updated total screw count and the rundown time in mS(milli-seconds).

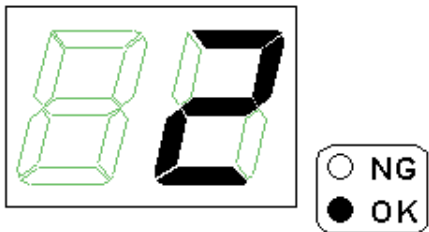
A WORK (OK)
< 0000001 > 1230mS



-  Adjust count "-1"
-  Adjust count "+1"
-  Total count number save

Saving the Cycle Count Data: Press the Enter Key  at any time to save the Cycle Count Data. Before you toggle through any Mode, be sure to save your Cycle Count Data. Before you unplug the unit, be sure to save the Cycle Count Data.

Improper Fastening - "NG"

When a fastener's rundown is not completed within the tolerance setting, the Scout's screen will display "NG" and display the type of error that occurred.

A WORK (ERROR)
TIME LAPSE 0810mS

Fastening OK

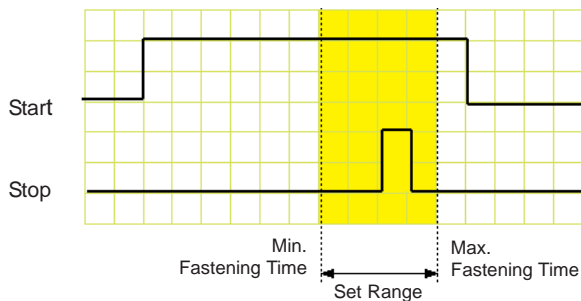

Fastening ERROR 1 - TIME LAPSE

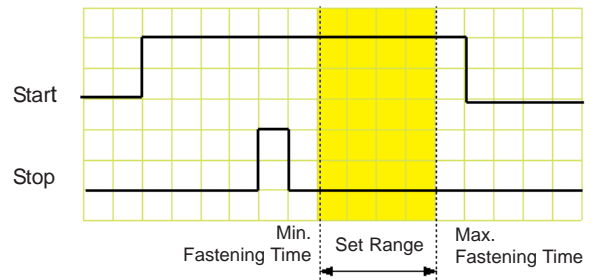

Fastening ERROR 2 - TIME OVER

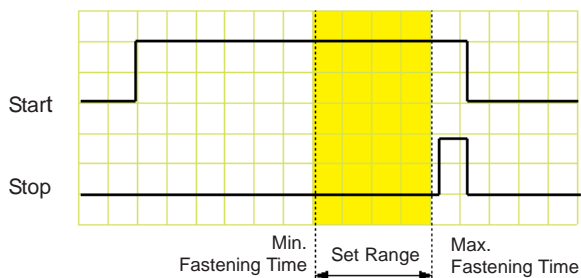

Fastening ERROR 3 - NO TORQUE UP

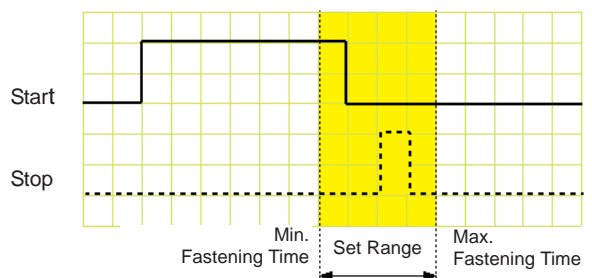



Scout (Screw Counter) v 2.0 Operating Instructions

(Rev 2.0 10/10/11)

Parameter Setting Menu

PRG	MIN	MAX	NO
A	1230	1330	12

-  Moves Cursor to the right
-  Select digits & letters (A-G)
-  Save

When setting the parameter use the keys as shown above for setting.





PRG: Select a parameter setting A-G (You can store 7 different settings overall). With each parameter setting you can set and store the Minimum and Maximum tolerances for a fastener rundown time, as well as the total number of screws for a completed assembly.



MIN: Minimum Fastening time

MAX : Maximum Fastening time

NO: Total number of screws for a completed assembly.

Note: If you don't know how long it takes on average to rundown your screw, go to the "Fastening Time Measurement Mode" (pg 9). You can perform a rundown analysis for your screw.

1. To select a Parameter setting. Press the Menu Key. Then press the  Right Key to toggle through the different Parameter Settings (A-G). Then tap on the  Left Key to move to the "MIN" digit and press the  Right Key to toggle through the digits. Remember the time is set in milli-seconds. Then tap on the  Left Key to move to the "MAX" digit and press the  Right Key to toggle through the digits.

Then tap on the  Left Key to move to the "NO" digit and press the  Right Key to toggle through the digits to program the number of screws to complete the assembly (Max 99).

2. Press the  Enter Key to Save the Parameter Setting.
3. Then Press Menu Key several times until the Work Mode Screen appears then start the assembly process.



A WORK (OK)
< 0000001 > 1230mS

Cycle Start Setting Mode

You can select how the Scout will count and monitor the assembly process.

1. With the "Auto" cycle start, it starts counting automatically when you starting using the electric screwdriver. Select this mode when you are not connecting the Scout to a PLC, sensor, switch or other source.
2. With the "Out Signal 1,2,3 & 4" cycle start, a signal from the PLC, switch, sensor or other source activates the Scout to start counting.

CYCLE START BY
<AUTO>

-  Cursor move to right
-  "Up" key
-  Save

Press the Menu Key until you get to the Cycle Start Mode. Press the Right Key for selecting Auto or Out Signal, then Press the Enter Key to save the selection by the enter key.

Scout (Screw Counter) v 2.0 Operating Instructions

(Rev 2.0 10/10/11)

Fastening Time Measurement Mode

This mode allows you to perform an analysis on the rundown time it takes to properly fastener the screw for your application. This information is a good tool for determining the guideline for your parameter setting.

FASTENING TIME
<1230 mS>

 Delete the latest data (-1)

 Data Clear

 Display AVE / MIN / MAX

1. Select the Fastening Time Measurement Mode.
2. Run the fastener down. The unit will display the rundown time of the fastener. The rundown time is shown in mS (milli-seconds). You can then perform another rundown. The unit can store a maximum of 20 measurements. The Fastening Time mode allows you to perform an analysis for determining the average time that is required for a proper rundown.
3. If you perform a bad rundown, like not completing the rundown of the fastener, then you can hit the Right Key  and the data from that rundown is deleted.



Total number of rundowns completed

AVE 1230mS (05)
MIN0920 / MAX 1350

4. To display the analysis of the rundown(s) completed, tap the Enter Key. 
5. The screen shows the Average rundown time of the fastener along with the Min and Max rundown(s).
6. The analysis provides you data for setting the tolerances of fastening a screw. You may want to add .0500 mS to the Min and Max settings.
7. If you change the type of screws being used, the application material, the joint, the torque setting of the driver or change the speed of the driver (transformer), you need to perform an another rundown time analysis because any of those factors can modify the rundown time of the fastener.

Total Count Number Reset (Save Total Cycle Count)

COUNT RESET
< NO >

1. After selecting the Total Count Number Reset mode, press the Right Key  for selecting Yes or No. Then hit  the Menu key to enter your choice.
 - With selecting "Yes" - the total number of screws counted is deleted.
 - With selecting "No" - the total number of screws counted will be saved.

Scout (Screw Counter) v 2.0 Operating Instructions

(Rev 2.0 10/10/11)

Buzzer Setting Mode



This mode allows you to select sound or no sound for each screw fastening process that is completed for the “OK” Buzzer or “NG” Buzzer. You can also select the number of times you want the Buzzer to repeat it’s sound after each screw fastening process.

SCREW OK BUZZER

Screw OK Buzzer
(No Sound) (0.1S) (0.2S) (0.3)
(0.4S) (0.5S) (1S) (2S) (5S)

 Right Key

 Save Key



1. For selecting “Sound” or “No Sound” when the screw fastening process is completed properly (OK Signal), press the Menu button until “Screw OK Buzzer” appears.
 2. For “No Sound” press the Right Key  until “No Sound” appears.
1. For selecting sound press the Right Key  and toggle through the different buzzer sounds length options. Press the Save Key  for selecting the buzzer sound length option that you want. The buzzer sound length options are: (0.1S) (0.2S) (0.3) (0.4S) (0.5S) (1S) (2S) (5S).

SCREW OK BUZZER REPEAT

SCR OK BZ REPEAT
(1 TIME) (2 TIMES) (3 TIMES)
(4 TIMES) (5 TIMES)

 Right Key

 Save Key



1. For selecting the number of times you want the OK buzzer sound to repeat, press the Menu button until “SCR OK BZ REPEAT ” appears.
2. Press the Right Key  and toggle through the different buzzer repeat options. Press the Save Key  for selecting the buzzer repeat option that you want. The buzzer repeat options are: (1 TIME) (2 TIMES) (3 TIMES) (4 TIMES) (5 TIMES)

SCREW NG BUZZER

Screw NG Buzzer
(No Sound) (0.1S) (0.2S) (0.3)
(0.4S) (0.5S) (1S) (2S) (5S)

 Right Key

 Save Key

1. For selecting “Sound” or “No Sound” when the screw fastening process is completed improperly (NG Signal), press the Menu button until “Screw NG Buzzer” appears.
 2. For “No Sound” press the Right Key  until “No Sound” appears.
1. For selecting sound press the Right Key  and toggle through the different buzzer sounds length options. Press the Save Key  for selecting the buzzer sound length option that you want. The buzzer sound length options are: (0.1S) (0.2S) (0.3) (0.4S) (0.5S) (1S) (2S) (5S).

Scout (Screw Counter) v 2.0 Operating Instructions

(Rev 2.0 10/10/11)



Buzzer Setting Mode Continued

SCREW NG BUZZER REPEAT

SCR OK BZ REPEAT
(1 TIME) (2 TIMES) (3 TIMES)
(4 TIMES) (5 TIMES)

 Right Key

 Save Key



1. For selecting the number of times you want the NG buzzer sound to repeat, press the Menu button until “SCR NG BZ REPEAT ” appears.
2. Press the Right Key  and toggle through the different buzzer repeat options. Press the Save Key  for selecting the buzzer repeat option that you want. The buzzer repeat options are: (1 TIME) (2 TIMES) (3 TIMES) (4 TIMES) (5 TIMES)

CYCLE OK BUZZER

Cycle OK Buzzer
(No Sound) (0.1S) (0.2S) (0.3)
(0.4S) (0.5S) (1S) (2S) (5S)

 Right Key

 Save Key



1. For selecting “Sound” or “No Sound” when the screw fastening cycle is completed properly (OK Signal), press the Menu button until “Cycle OK Buzzer” appears.
 2. For “No Sound” press the Right Key  until “No Sound” appears.
1. For selecting sound press the Right Key  and toggle through the different buzzer sounds length options. Press the Save Key  for selecting the buzzer sound length option that you want. The buzzer sound length options are: (0.1S) (0.2S) (0.3) (0.4S) (0.5S) (1S) (2S) (5S).

CYCLE OK BUZZER REPEAT

CYC OK BZ REPEAT
(1 TIME) (2 TIMES) (3 TIMES)
(4 TIMES) (5 TIMES)

 Right Key

 Save Key

1. For selecting the number of times you want the OK buzzer sound to repeat, press the Menu button until “CYC OK BZ REPEAT ” appears.
2. Press the Right Key  and toggle through the different buzzer repeat options. Press the Save Key  for selecting the buzzer repeat option that you want. The buzzer repeat options are: (1 TIME) (2 TIMES) (3 TIMES) (4 TIMES) (5 TIMES)

Scout (Screw Counter) v 2.0 Operating Instructions



(Rev 2.0 10/10/11)

Buzzer Setting Mode Continued

CYCLE NG BUZZER

Cycle NG Buzzer
(No Sound) (0.1S) (0.2S) (0.3)
(0.4S) (0.5S) (1S) (2S) (5S)



 Right Key
 Save Key

1. For selecting “Sound” or “No Sound” when the screw fastening cycle is completed improperly (OK Signal), press the Menu button until “Cycle NG Buzzer” appears.
2. For “No Sound” press the Right Key  until “No Sound” appears.
1. For selecting sound press the Right Key  and toggle through the different buzzer sounds length options. Press the Save Key  for selecting the buzzer sound length option that you want. The buzzer sound length options are: (0.1S) (0.2S) (0.3) (0.4S) (0.5S) (1S) (2S) (5S).

CYCLE NG BUZZER REPEAT

CYC NG BZ REPEAT
(1 TIME) (2 TIMES) (3 TIMES)
(4 TIMES) (5 TIMES)

 Right Key
 Save Key

1. For selecting the number of times you want the NG buzzer sound to repeat, press the Menu button until “CYC NG BZ REPEAT ” appears.
2. Press the Right Key  and toggle through the different buzzer repeat options. Press the Save Key  for selecting the buzzer repeat option that you want. The buzzer repeat options are: (1 TIME) (2 TIMES) (3 TIMES) (4 TIMES) (5 TIMES)

Scout (Screw Counter) v 2.0 Operating Instructions

(Rev 2.0 10/10/11)

Password Setting

The default Password is "0000". The Password is needed for the parameter setting after every time the unit is powered on. Once the password is entered, there is no need to enter the password again for the parameter setting, unless the unit is turned off.



PLEASE PASSWORD ?
< ? ? ? ? >

 Moves the cursor to the right

 Right key to select digits



 Enter

To enter password:

1. To toggle through four digits tap on the Left Key. 
2. Press the Right Key  to select numbers.
3. Tap the Enter Key  once you have entered the password.

PLEASE CHANGE ?
< * * * * >

The password can be changed. You can only select numerical numbers (1-9) for each digit. You need to select four numbers.

1. To toggle through four digits tap on the Left Key. 
2. Press the Right Key  to select a number for each digit opening.
3. Tap the Enter Key  once you have selected the new password.

Notes: If you press the Enter Key  without selecting a new password setting, it automatically sets the password at "0000".

Do not forget the password. If the password is lost or forgotten, there is no way to recover it.

Scout (Screw Counter) v 2.0 Operating Instructions

(Rev 2.0 10/10/11)

SIGNAL IN Controls for PLC

Listed are four examples for connecting the Scout to a PLC, switch, sensor or other source. There are four Assembly Operation examples illustrating the Scout being interfaced with a PLC, switch, sensor or other source.

Signal IN (Type 1)

PLC Controlled - Auto Assembly Line with Pallet Conveyor System



In order to control the flow of the work-piece to next process automatically, the SCOUT works with the PLC for transmitting signals of the fastening "cycle start" and "cycle end" process.

In the "Cycle Start By" mode, select and save the "Type 1". The PLC provides the "cycle start" signal (pulse) to the SCOUT as quickly as the work-piece arrives at the worktable. Then the SCOUT is ready to monitor the screw fastening process. Once the required number of screws is fastened properly, the SCOUT sends a signal (pulse - 0.5S) to the PLC to alert it that the "cycle end" process has occurred. Then PLC will make another process.

With a semi-auto assembly line, the operator can push the button for every "cycle start" as soon as picking up the work-piece from the conveyor belt and taking it to the worktable. Pushing the button sends the signal (pulse - 0.5S) to the SCOUT.

Signal IN (Type 2)

Semi-Auto Assembly Line with Belt Conveyor System

Type 2 provides the alert buzzer if the piece is moved prior to the cycle being completed.

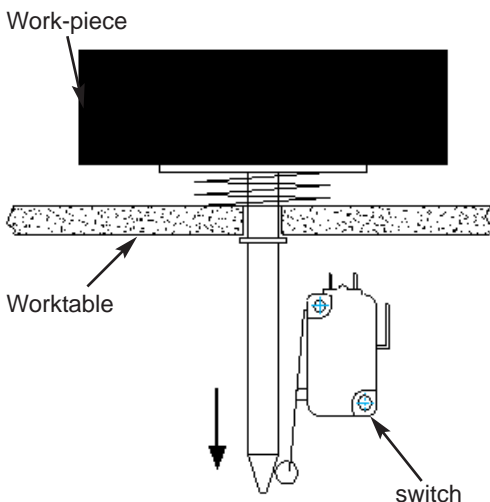

If the operator moves the work-piece to the next process before the required number of screws is fastened properly, the Scout would send a signal that the "cycle end" process has not occurred, which would trigger a continuous alert buzzer until the work-piece is placed back on the work table.

This quality control system prevents missed screw fastening. In order to use this example, you need to set the switch on the worktable, but under the work-piece. The operator always should put the work-piece on the switch device before working.

In the "Cycle Start By" mode, select and save the "Type 2".

Scout (Screw Counter) v 2.0 Operating Instructions

(Rev 2.0 10/10/11)

Signal IN (Type 3)

Using Optical or Magnetic Sensors for an Alert Buzzer for Semi-Auto Assembly Line with Belt Conveyor System

Similar to Example (Type 2), if the operator lifts the work-piece up for any reason, like inspecting it, the SCOUT will recognize the work-piece as being moved out and trigger an alert buzzer. In this case (Type 3) is a suitable solution for detecting work-piece. This process requires two signals for the work-piece coming IN and OUT using the optical or magnetic sensors.

In the "Cycle Start By" mode, select and save the "Type 3".

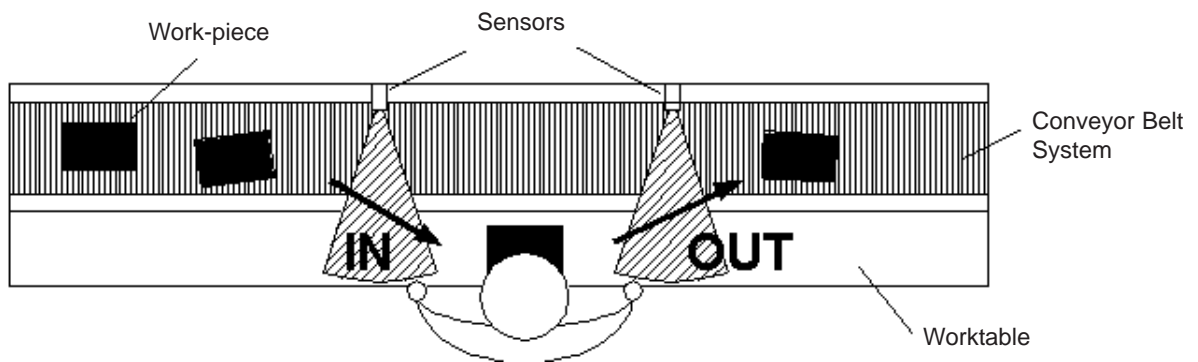

Signal IN (Type 4)

Using Optical or Magnetic Sensors for an Alert Buzzer for Semi-Auto Assembly Line with Belt Conveyor System

This example is similar to Example (Type 2) but instead of switch an optical sensor is used. Using an optical sensor that can detect an object within a certain range, the operator can lift up the work-piece during the cycle for any reason and the SCOUT would not trigger an alert buzzer. However, if the operator takes the work-piece out of range of the optical sensor then the SCOUT will recognize it and trigger an alert buzzer.

In the "Cycle Start By" mode, select and save the "Type 4".

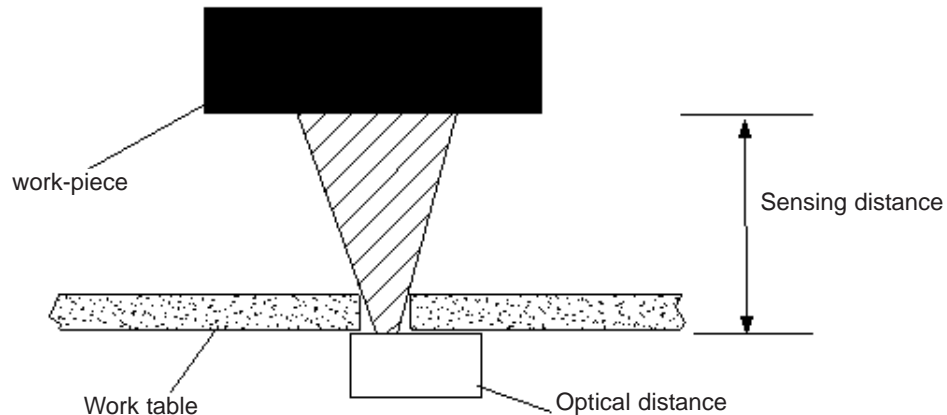



Scout (Screw Counter) v 2.0 Operating Instructions

(Rev 2.0 10/10/11)

Mountz Calibration & Repair Services

Mountz Inc. features an experienced calibration and repair staff. Our trained technicians can calibrate and repair most any tool. Mountz provides rapid service with quality that you can trust as we offer three state-of-the-art calibration lab and repair facilities that can calibrate up to 20,000 lbf.ft.

With over 45 years of experience, Mountz's in-depth knowledge of torque is reflected in our tool's craftsmanship and our ability to provide solutions to both common and uncommon torque applications. We perform calibrations in accordance with ANSI/NCSL-Z540. Mountz is dedicated solely to the manufacturing, marketing and servicing of high quality torque tools.

Mountz is an ISO 9001 certified and ISO 17025 accredited company.

Tool Service & Repair Capability

- Torque Wrench Calibration: Click Wrench, Dial Torque Wrench, Beam Wrench, Cam-Over & Break-Over Wrench
- Torque Screwdrivers: Dial, Micrometer, Preset & Adjustable
- Torque Analyzers/Sensors: All brands
- Electric Screwdrivers: All brands
- Air Tools: All brands
Impact Wrenches, Drills, Pulse Tools, Grinders, Percussive Tools, Air Screwdrivers, Nutrunners, DC Controlled Nutrunners
- Torque Multipliers: All brands

Mountz Torque Testers and Calibration Equipment

Torque tools go out of calibration with use. Calibrating a torque tool is a fine-tuning process of bringing the tool back within its tolerance. Torque testers can also be used for quick tools tests on the line or in the lab to determine whether torque tools are holding a given setting.

A regular torque tool calibration and re-calibration guarantees the operator repeatable accuracy and adherence to international standards. Torque testing also ensures torque equipment is operating to peak performance and can highlight potential tooling problems before they arise perhaps due to tool wear or broken components.

Controlling torque is essential for companies to ensure their product's quality, safety and reliability isn't compromised. The failure of a three-cent fastener that isn't properly tightened can lead to catastrophic or latent failures. Fasteners that are insufficiently torqued can vibrate loose and excessive torque can strip threaded fasteners. Using a quality torque tool has become increasingly important for many companies to ensure that proper torque is being applied and maintains gauge requirements associated with the ISO 9001 Quality Standard. Look for the Mountz hexagon logo - it's a stamp for quality tools, service and knowledge in the field of torque control.

Mountz Service Locations

Eastern Service Center

19051 Underwood Rd.
Foley, AL 36535
Phone: (251) 943-4125
Fax: (251) 943-4979

Western Service Center

1080 N.11th Street
San Jose, CA 95112
Phone: (408) 292-2214
Fax: (408) 292-2733

Mexico Service Center

Mountz Mexico SA de CV Chihuahua
Av. Cristobal Colon #15343
Col. Paseos de Chihuahua
Chihuahua, Chih. Mexico CP 31125
Phone: (614) 481-0023
Fax: (614) 481-0053

www.mountztorque.com
sales@mountztorque.com

Download a "Service Form" and include a copy when you send the tools in to be serviced.

Looking for fasteners?
www.mrmetric.com

