

YF-Series Operation Instructions

Rev 2.1 (9/20/13)



YF-Series Operation Instructions

Key Features

- Various models that range from 6.1 - 86.8 lbf.in
- High performance brushless motor design provides durability and reduces the standard maintenance costs for electric screwdrivers.
- Designed for high production environments. Minimal heat build-up even when tool is operated continuously.
- Over Heat Protection (OHP) and Over Current Protection (OCP) protect driver from damage or malfunction. Features a LED display that signals the tool status for the operator to view.
- Can be connected with the Scout Screw Counter.
- Requires controller (power supply).
- All models are ESD designed and prevent the occurrence of electrostatic discharge, which improves production yields, manufacturing costs, product quality, product reliability, reputation and profitability.
- Programmable soft start, speed, angle, auto-reverse feature.
- Programmable three step multi-sequence, CW angle, CCW angle, holding time.
- Programmable Multi-Hit Mode for soft joints.



YF-Series brushless electric screwdriver

Electric specification
Input : 35VDC, 3A max



YFC-35D Controller



**Power Tool Cable for YF-Series
Length: 3m**

YF-Series Operation Instructions

General Operation for YF-Series models

1. Attach power tool cable to the YF screwdriver and YFC-35D Controller. Make sure notch in plug lines up with the notch on the socket. Tighten knurled ground ring.
2. Plug in power cord to the back of the YFC-35D Controller and power outlet. Flip power switch to "ON" position located on the back of controller.
4. Select a bit. Retract the bit collar. Insert the bit and release the retracted collar. To avoid damaging fasteners, make sure the proper bit is suitable for the head of the fastener.
5. The torque limit is determined by the tension of the coil spring housed in the torque adjustment nut. The tighter the coil spring is wound the higher the torque limit is raised. See Torque Charts on page 10 to determine the appropriate torque adjustment setting.
6. Rotate the torque adjustment nut to set the torque limit. Turn clockwise to increase torque and counter clockwise to decrease torque. The scale adjacent to the Torque Adjustment Nut is a reference guide. The torque output from the driver can change depending on various fastening factors like friction, type of joint, and the type material being used like a washer. Verify torque setting with a torque testing system.
7. Turn driver on and check for proper rotation. FOR-clockwise, REV-counterclockwise.
8. To apply torque, squeeze the lever (Push-to-Start models - place light downward pressure on the nose of the driver). The driver will automatically stop when the preset torque has been reached.
9. To remove the screw, turn the FOR/REV switch to REV position.



Alarm display by LED

no	Alarm	Description	Reset
1	Over Voltage (over 37V)	● RED Light On-Off blink (0.5s)	Auto reset under 37V
2	Overload (8A / 0.5s)	● RED Light On-Off blink (0.5s)	Auto reset after 5s
3	Overheat (over 80°C of motor)	● RED Light On-Off blink (0.5s)	Auto reset lower than 80°C
4	Driver Lock by external signal	● RED Light On continuously	Reset by signal off
※	Torque Up	● RED Pulse light 	

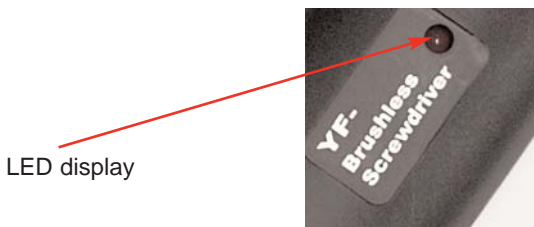

Dimensions: for PYF35N, PYF50N, PYF100N

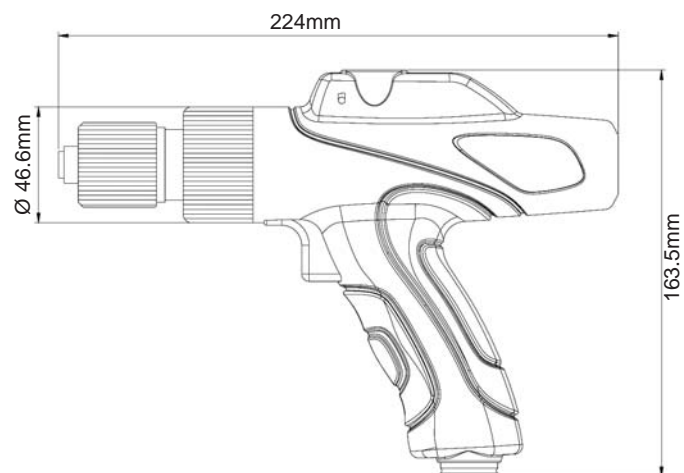

YF-Series Operation Instructions

Dimensions: for YF35N, YF50N, YF100N,

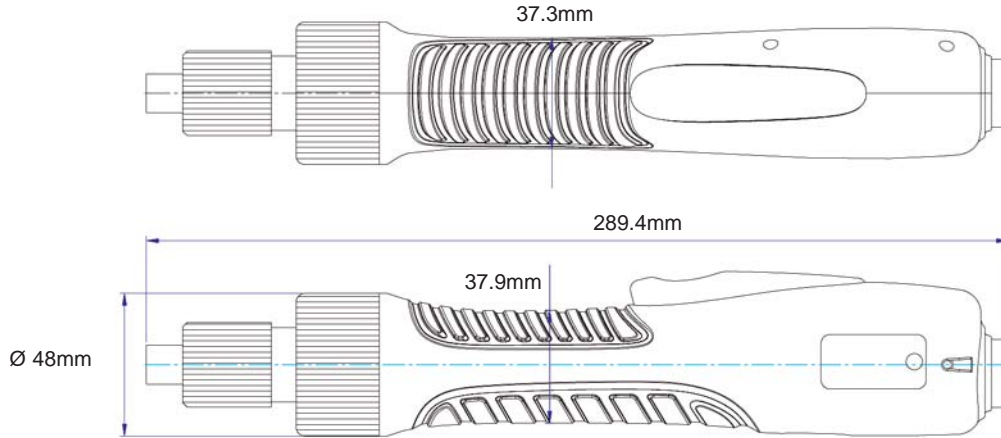

Controller Specification

Model	YFC-35D
Safety certificate	NRTL by MET (USA & Canada)
Rated Input	120 VAC 60Hz, 2.5A
Rated Output	35 VDC ±5%, 140W
Maximum output current	10 A
Intermittent operation	10s On / 30s Off
Dimensions	95(W) x 221(D) x 143(H) mm
Weight	2.4 Kg
Connectable screwdrivers	YF-35N, YF-50N, YF-100N YF-35NP, YF-50NP PYF-35N, PYF-50N, PYF-100N
Firmware version display	on the back label

Controller Drawing

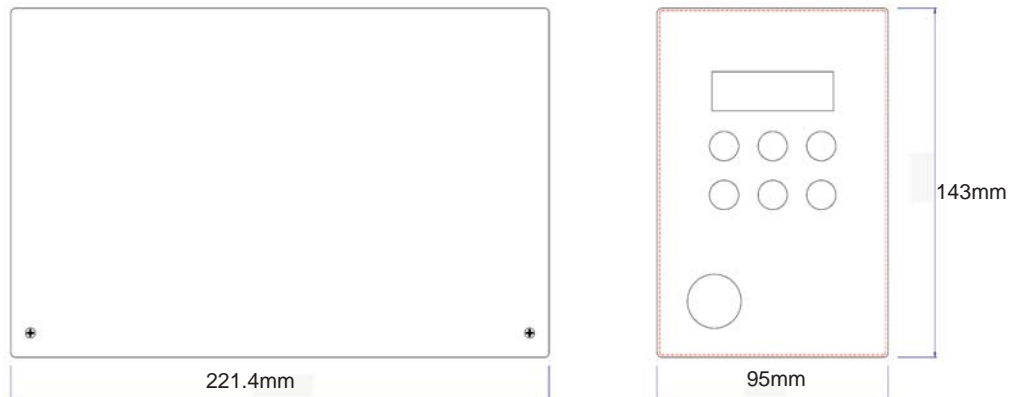

YF-Series Operation Instructions

Over Current Protection (Overload), Over Heat Protection Details

Description		Over Current Protection	Over Heat Protection
Detection	Limit	8 A current	90 °C
	Time duration	immediately	
Protection		Whole power shut down permanently	
Protection signal	LED	No power	
	Buzzer	No power	
Recovery		Turn off the power switch and on after 1 min.	Turn the power switch off and on at lower than 90°C temperature.

Operation (Button Functions for the Controller)



There are 4 Modes that can be selected.

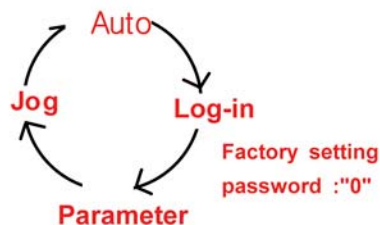

MODE button

A Mode setting can be selected by pressing the MODE button. A password is required before being able to make a change. The controller rotates through each Mode option (Auto, Log-in, Parameter and Jog). Auto means operational mode for the tool. Once a Mode is selected, the Mode setting will stay active until the controller is powered OFF. All settings are possible in the Parameter mode.

YF-Series Operation Instructions

Operation (Button Functions for the Controller) - Continued



button

Log-in Mode:

Log-in is required for accessing parameter setting. Initial password is "0". It can be changed on PYORD (in Parameter Setting).

Parameter Mode:

Cursor shift up to left at the Parameter mode.



button

Auto (Work) Mode:

Select the next preset number.

Log-in & Password:

Increase the number up.



button

Auto (Operation) Mode:

<u>Time</u>	<u>FND Display</u>	<u>Description</u>
Initial	0A000	Initial display at the Auto (Work) mode
1st	t	Display the temperature of driver inside (unit : 0.1°C)
2nd	F	The latest Fastening time (unit: mS)
3rd	L	The latest Loosening time (unit: mS)
4th	Pc	The latest current value (unit : 0.1A)
5th	tu	The latest Fastening turns (unit: 0.1 turn)
6th	SF Lo	Status of Start & Torque up sensor (F:off, o:on) Initial status : SF LF
7th	r 0	Real-time rotation speed

Parameter Mode:

Decrease the number down.

Jog Mode:

Manual stop by button.



**Enter
button**

Parameter Mode:

Select or save the chosen display.

Jog Mode:

Manual start by button.



button

Returns to the previous mode. Also it resets the error.



YF-Series Operation Instructions

Parameter Settings

1. Click MODE and select (PARA) on the screen for parameter configuration. Click ENTER for configuration options.
2. Press arrow Up or arrow Down to toggle thru all (15) parameter sets available.
3. Select the parameter you need to select and press ENTER.

Model	YF35N,YF35NP	YF50N,YF50NP	YF100	PYF35N	PYF50N	PYF100N
Number	30n	45n	90n	35n	50n	100n

Driver Model Selection P1 (ModEl)

Choose one of the model between 30n, 45n, 90n, 35n, 50n and 100n for the connected screwdriver (see chart above).

Note! If wrong model is selected, then the speed and torque settings will not properly match the specifications as listed on data sheet. And not properly function.

Fastening Speed P2 (F_SPD)

Change rotation speed for forward fastening. Depending on the selected screwdriver model, the min and max speed is automatically limited to the speed range as stated in specification chart on data sheet.

Loosing Speed P3 (L_SPD)

Change rotation speed for reverse loosening. Depending on the selected screwdriver model, the min and max speed is automatically limited to the speed range as stated in specification chart on data sheet.

Soft Start P4 (F_Acc)

The motor acceleration time to the target speed can be adjusted from 30 to 2000mS. The factory setting is 50mS.

Note! Time setting of soft start can change the tightening torque for short screw or re-tightening a screw that's already fastened.

Soft Start for Reverse Operation P5 (L_Acc)

The motor acceleration time to the target speed in Reverse rotation can be adjusted from 30 to 2000mS. The factory setting is 50mS.

Multi-Hit Setting P6 (M_hit)

Number of torque up by clutch can be selected from 1 to 10 times. Factory setting is 1 time.

The Multi-Hit mode is for very soft joint applications. When an electric screwdriver runs down a fastener and the tool clutches off once the preset torque is achieved there can be some joint relaxation that can occur. The Multi-Hit mode allows the electric screwdriver perform multiple hits to stabilize the torque for joint relaxation.

Joint relaxation is caused by the surface of part(s) embedding or by "soft parts" such as gaskets, plastics or spongy material, which collapses under the clamping force created in a torque condition. For Hard Joint applications there is no need to use the Multi-Hit mode.

The clutch of the electric driver works multiple times at the set torque under the "Multi-Hit" mode.

Multi-Sequence P7 (M_FSt)

Available to program multi step operation in sequence.

(0) oFF : Disable (1) on : Enable

Multi-1 : First Angle in Turn P8 (Frt.Ag)

Angle setting for angle stop in turns from 0 to 9999 (1 unit = 0.1 turn)

Multi-2 : Second Reverse Angle for Next Step of Operation P9 (rEV.Ag)

Angle setting for angle stop in turns from 0 to 9999 (1 unit = 0.1 turn)

Multi-3 : Holding Time for Next Step of Operation P10 (hLd.ti)

Time setting of holding to next step from 0 to 99 (1 unit = 0.1 sec)

YF-Series Operation Instructions

Parameter Settings (Continued)

Display setting P11 (dSP.Md)

Display setting between two:

0: number of speed setting 1 : real time speed

External I/O for Remote Control P12 (PLc.Md)

Available to use I/O for remote control.

0 oFF : Disable 1 on : Enable

Reverse torque control setting P13 (REvMd)

Reverse torque control can be selected between ON/OFF . Factory setting password is "on"

on : Stop by torque up off : Slip

Password Setting P14 (PYord)

Setting new password. Factory setting password is " 0 "

Parameter Initialization to Factory Setting P15 (Pinit)

All parameter will be changed to it's original torque setting. Password is "77"

Firmware version display P16 (VEr)

I/O Details (Porting Options)

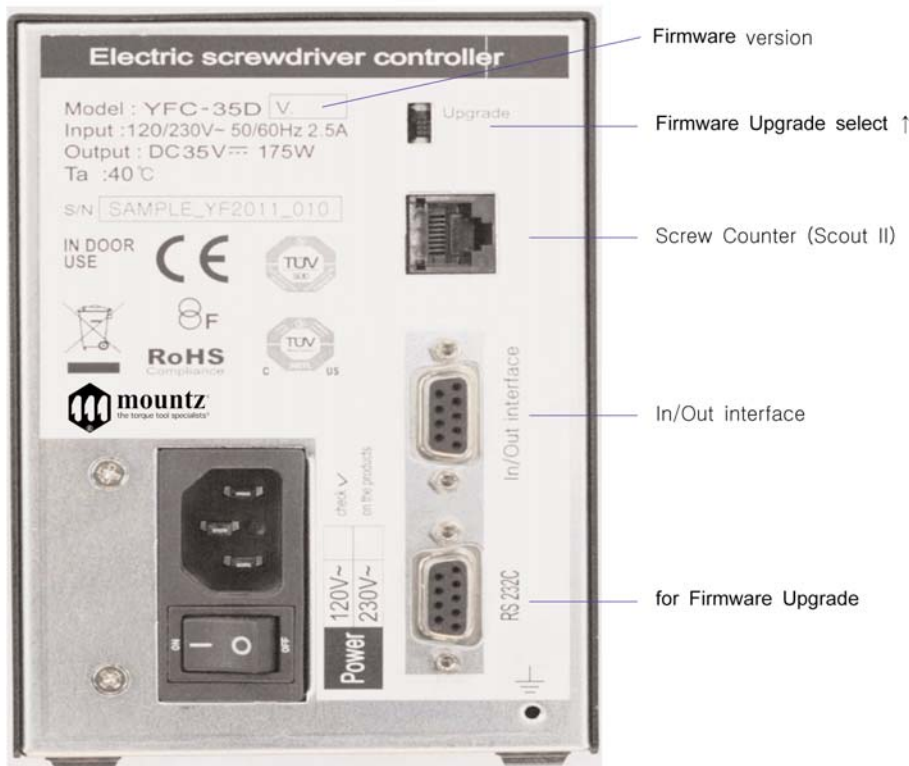

YF-Series Operation Instructions

I/O Interface Port Details (Back Panel)



Pin no.	In / Out	Interface
1	OUT	Torque Up
2		Motor Run
3		Out COM
4	IN	Remote Start
5		Driver Lock
6	X	
7		
8	IN	Reverse rotation
9		In COM

I/O Interface Connection Details

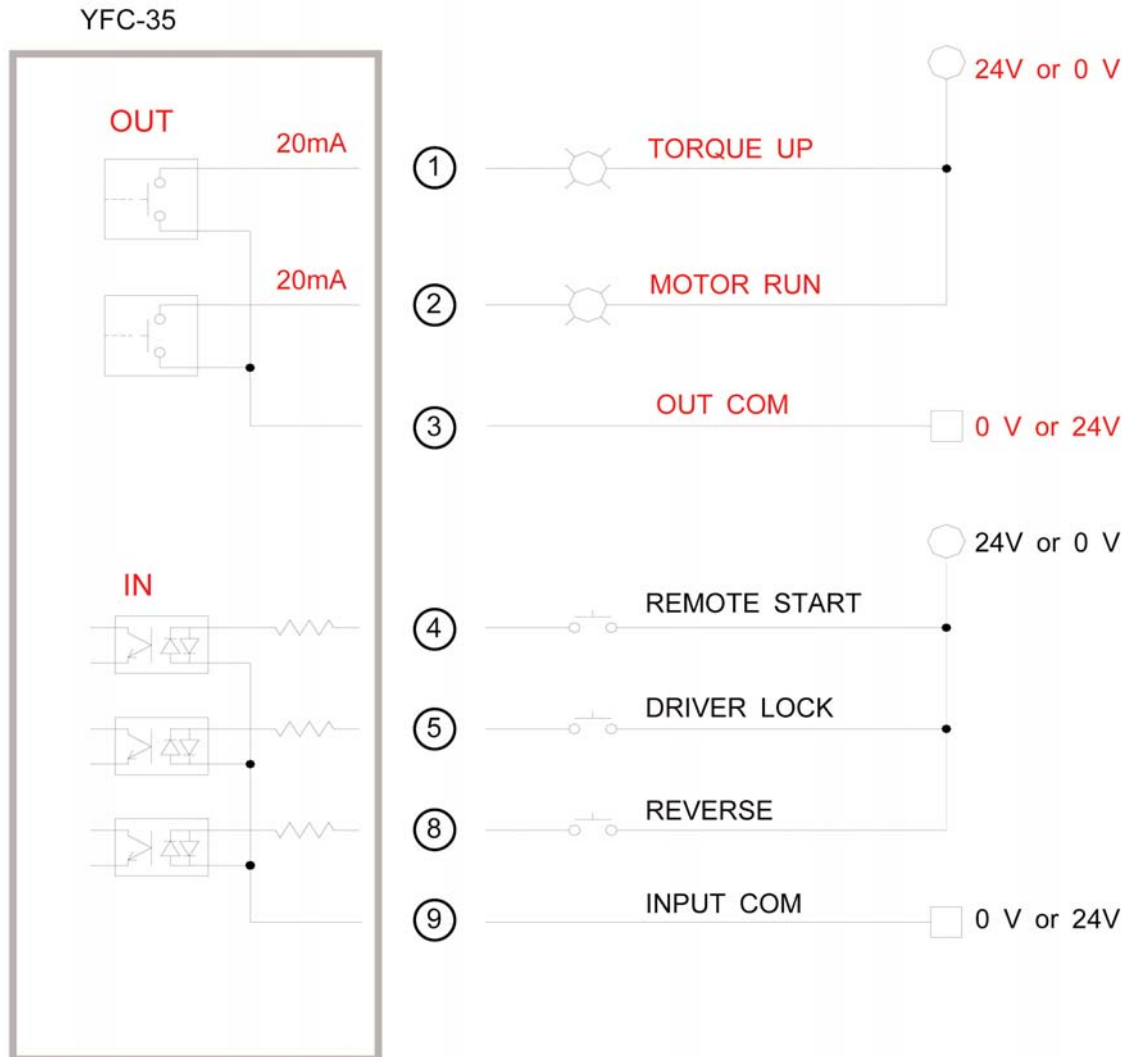

YF-Series Operation Instructions

Torque Charts

These charts are meant to be used as guidelines for setting the torque on the YF-Series electric screwdrivers. The drivers have a torque scale on the torque adjustment nut showing reference numbers. These numbers determine the approximate torque setting. Refer to the charts to determine the reference number setting for your torque requirement.

How to Read the Torque Charts

Torque ranges (lbf.in) approximate tightening torque, operated with no load at maximum speed. Verify torque setting with a torque testing system.

lbf.in YF30N & YF30NP

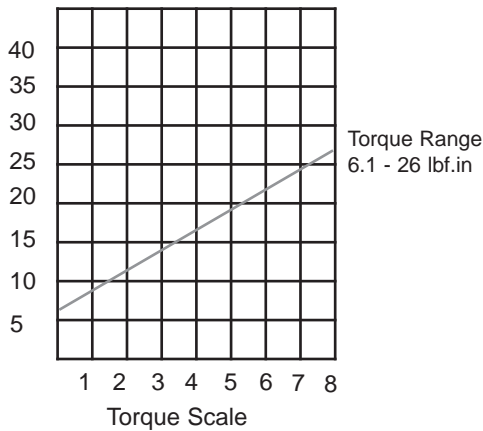

lbf.in YF90N

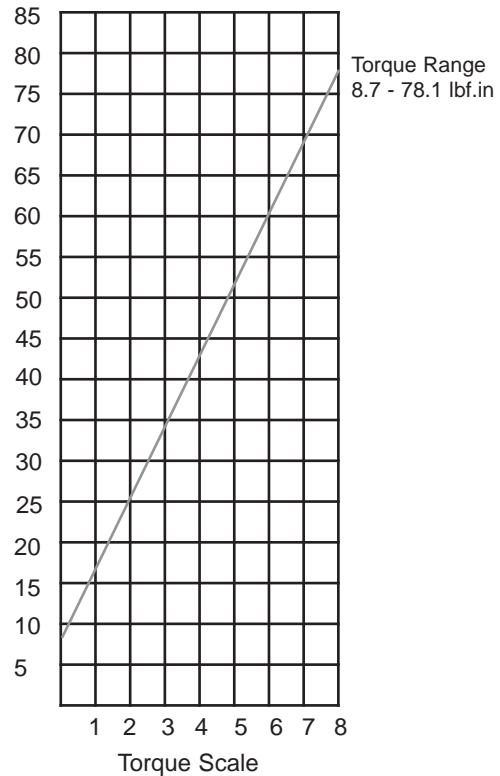

lbf.in YF45N & YF45NP

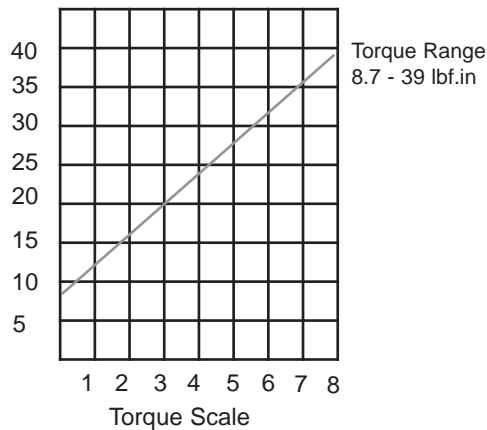

YF-Series Operation Instructions

Torque Charts

These charts are meant to be used as guidelines for setting the torque on the YF-Series electric screwdrivers. The drivers have a torque scale on the torque adjustment nut showing reference numbers. These numbers determine the approximate torque setting. Refer to the charts to determine the reference number setting for your torque requirement.

How to Read the Torque Charts

Torque ranges (lbf.in) approximate tightening torque, operated with no load at maximum speed. Verify torque setting with a torque testing system.

lbf.in PYF35N

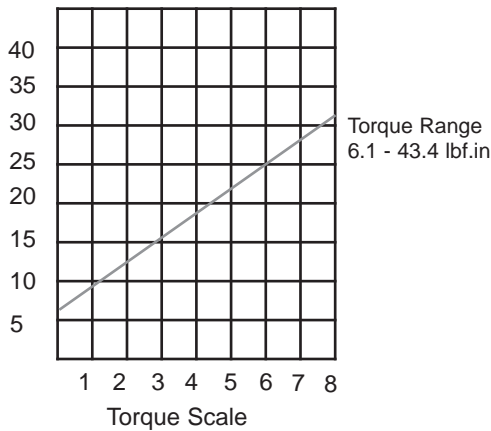

lbf.in PYF50N

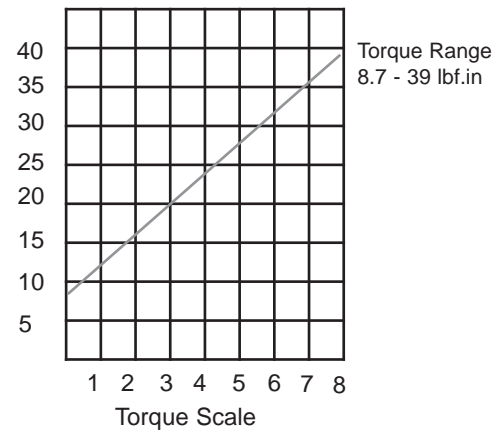

lbf.in PYF100N

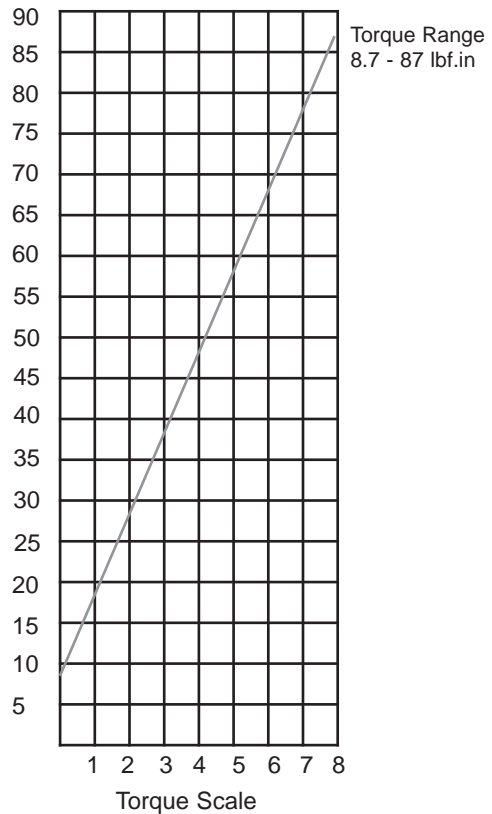

YF-Series Operation Instructions

Accessories

The EZ-Glider torque arms are designed to improve production and quality control during the assembly process. The arms securely keep electric or pneumatic drivers in perpendicular alignment to help prevent side loading or cross threading occurring during the assembly process. The EZ-Glider helps remove the operator's influence in the assembly process and strengthens quality control.

The ergonomic design of the EZ-Glider torque arms reduces RMI (repetitive motion injury) and CTS (carpal tunnel syndrome). The effortless handling of the torque arm provides comfortable tool operation and increased production. The torque arm can be installed in space-restricted areas



Scout screw counter helps manufacturers detect and eliminate costly screw-fastening errors during the assembly process. Using a screw counter is like putting the eyes and ears of a quality control manager where they are needed most - right on the assembly area. The scout is designed to detect cross threading, omissions, unfinished rundowns and cycle complete. The screw counter takes the control of the assembly process out of the operator's hands.

Item # 145790

Screw presenters are small, tabletop devices used to organize and automate work areas and production cells. Screw presenters make assemblers and the assembly process more efficient by mechanically presenting a screw to a fixed pick up point. The inexpensive screw presenter is an alternative tool instead of the cumbersome and very expensive screwfeeder systems.



YF-Series Operation Instructions

RPM for Electric Screwdrivers

Models	RPM Adjustable
YF35N-A ESD	500-1500
YF35NP-A ESD	500-1500
PYF35NP-A ESD	500-1500
YF50N-A ESD	400-1100
YF50NP-A ESD	400-1100
PYF50NP-A ESD	400-1100
YF100N-A ESD	250-500
PYF100NP-A ESD	250-500



Testing Power Tools:

1. Application Method: Use a torque analyzer in “Peak Mode” with a rotary transducer between the power tool and the actual application. This is the best way to test since you are using the actual joint as the test station. You will see the actual torque applied to the fastener. **Caution:** Variances in tool performance may occur do to the addition of the rotary transducer.
2. Simulated Method: Always use a quality joint rate simulator (run down adapter) with a torque analyzer when testing power tools in a simulated application. Use Joint rate and Breakaway methods to obtain most accurate torque readings in a simulated rundown.

Care

1. The YF-Series screwdrivers are a precision torque control instrument and should be handled with care at all times.
2. Only use the controller listed in the Mountz catalog or website for appropriate YF-Series driver model (If you have any questions regarding the appropriate controller set-up, contact Mountz Customer Service Department).
3. Operate under safe conditions. Do not place in operation where such objects as hair, strings, clothing, etc. can become tangled in the rotating bit.
4. Keep away from moisture. Never use in high humid, moist or damp environment.

Service

Mountz Inc. features an experienced calibration and repair staff. Our trained technicians can calibrate and repair most any tool. Mountz provides rapid service with quality that you can trust as we offer three state-of-the-art calibration lab and repair facilities that can calibrate up to 20,000 lbf.ft.

Mountz, The Torque Tool Specialists®, has been a leader in the torque tool industry for more than 50 years. Engineered in the Silicon Valley and serving the globe, Mountz focuses on delivering high-quality torque products, services, and solutions to ensure customers can always proceed with confidence. We are committed to forging a safer world through precision and accuracy, and by innovating every day.

Tool Service & Repair Capability

Torque Wrenches: Click, Dial, Beam, Cam-Over & Break-Over

Torque Screwdrivers: Dial, Micrometer, Preset & Adjustable

Torque Analyzers/Sensors: All brands

Electric Screwdrivers: All brands

Air Tools: All brands

Impact Wrenches, Drills, Pulse Tools, Grinders, Percussive Tools,
Air Screwdrivers, Nutrunners, DC Controlled Nutrunners

Torque Multipliers: All brands

Mountz Service Locations

Eastern Service Center

19051 Underwood Rd.

Foley, AL 36535

Phone: (251) 943-4125

Fax: (251) 943-4979

Western Service Center

1080 N.11th Street

San Jose, CA 95112

Phone: (408) 292-2214

Fax: (408) 292-2733

www.mountztorque.com
sales@mountztorque.com