

CLS25 3/4 Sq Dr Parts Lists (Gearing)

Rev. 1.0

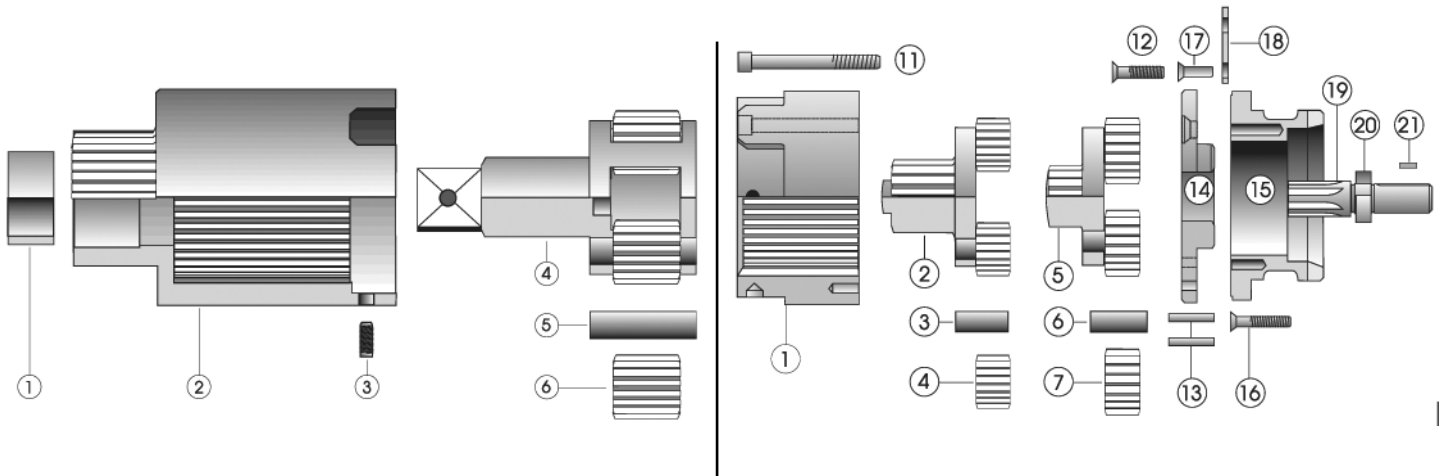
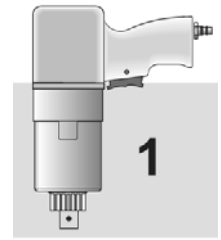

Section A

Ref #	Part #	Description	Qty
1	21-20143	Sieve	1
2	21-10210	Gear Housing	1
3	21-20020	Stud Bolts	4
4	21-10180	Gear Cage 3/4"	1
5	21-20011	Gear Pins	4
6	21-10146	Planet Gears	4

Section B

Ref #	Part #	Description	Qty
1	21-14148	Gear Housing	1
2	21-10165	Gear Cage	1
3	21-10142	Bearing Pins	3
4	21-10144	Planet Gears	3
5	21-10162	Gear Cage	1
6	21-10142	Bearing Pins	3
7	21-10145	Planet Gears	3
11	21-20044	Allen Screws	4
12	21-20027	Counter Sunk Screw	4
13	21-20001	Parallel Pin	4
14	21-14146	Gear Cover Plate	1
15	21-14102	Motor Flange	1
16	21-20027	Countersunk Screw	4
17	21-20024	Grooved drive stud	2
18	21-14108	Suspension eyelet	1
19	21-14111	Motor Shaft	1
20	21-14109	Shrink Ring	1
21	21-20139	Feather Key	1

CLS25 3/4 Sq Dr Parts Lists (Handle)

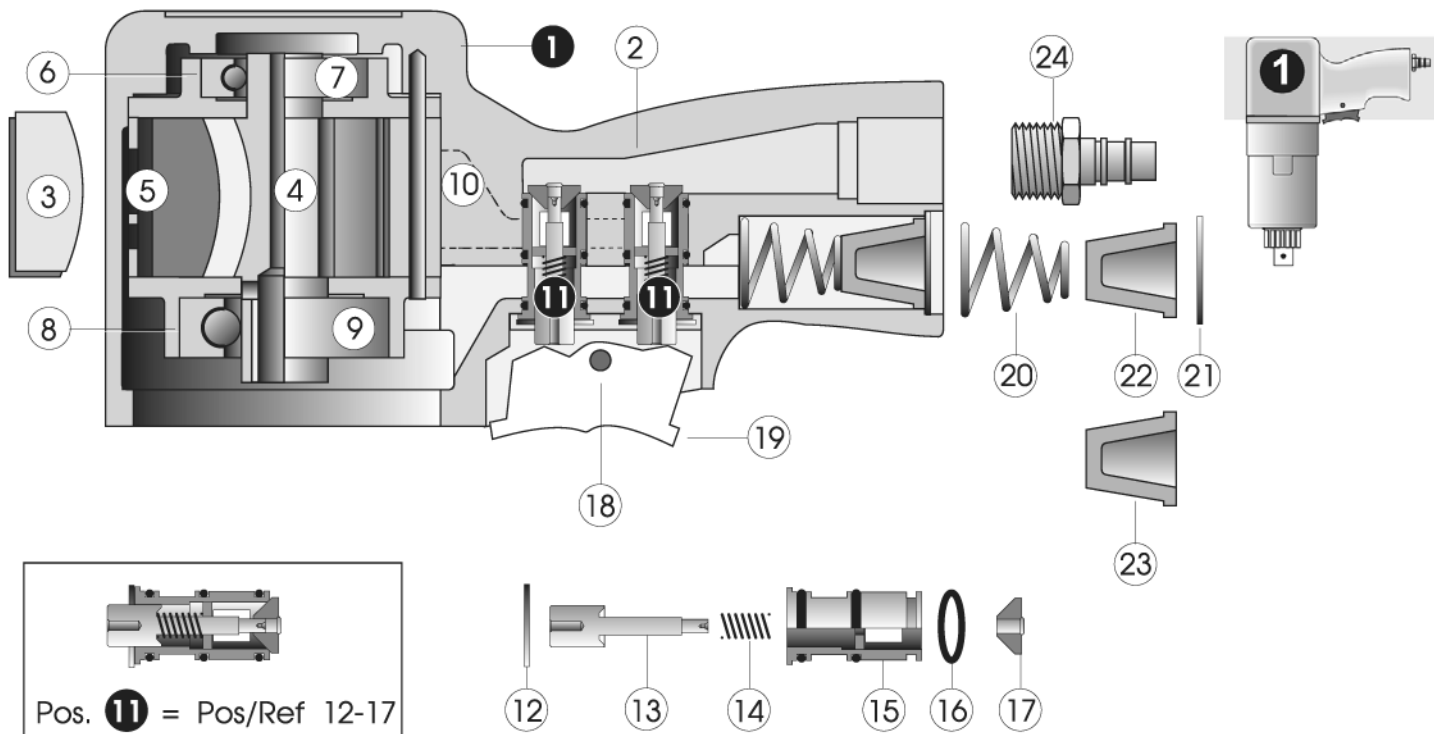

Ref #	Part #	Description	Qty
1	21-14600	Motor Compl	1
2	21-10602	Motor housing	1
3	21-14603	Plate	6
4	21-14604	Rotor	1
5	21-14605	Rotor Cylinder	1
6	21-14606	Cover plate	1
7	21-20118	Groove ball bearing	1
8	21-14608	Cover plate	1
9	21-20119	Groove ball bearing	1
10	21-2008	Parallel pin	1
11	21-14615	Valve Compl	2
12	21-20151	Circlip	1
13	21-14611	Valve Pin	1
14	21-20131	Spring	1
15	21-14613	Intake bush	1
16	21-20214	O-type sealing ring	3
17	21-14612	Semi-sphere	1
18	21-14618	Parallel pin	1
19	21-14617	Tilt lever	1
20	21-20134	Spring	1
21	21-20152	Circlip	1
22	21-14626	Filter	1
23	21-14627	Sound absorber	1
24	21-20361	Nipple	1