

EFW800 Plus (Motor)

Rev. 1.0

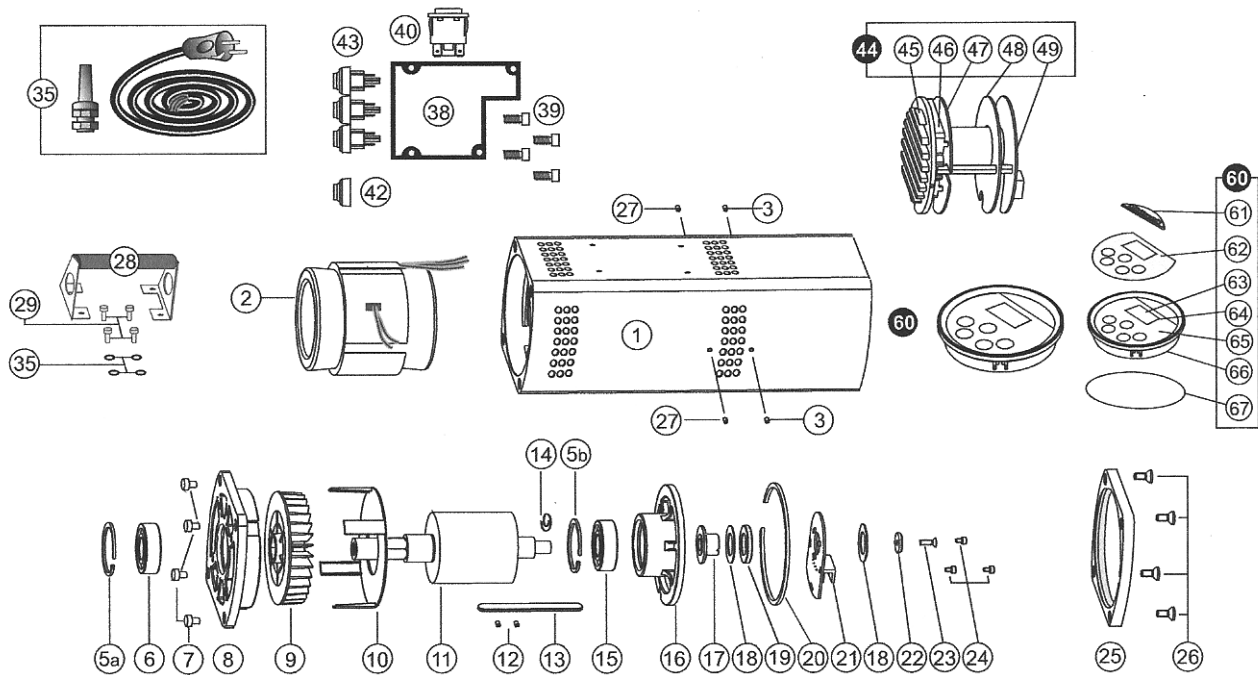

Ref #	Part #	Qty	Description	Ref #	Part #	Qty	Description
1	21-13501	1	EF housing	26	21-20026	4	Counter sunk screw
2	21-13616	1	Stator with cable & temperature sensors	27	21-20728	2	Stud bolt
3	21-20726	2	Stud bolt	28	21-16882	1	Handle
4	-	-	-	29	21-20079	4	Screws
5a	21-20719	1	Angular wheel	35	21-20077	4	Spring ring
5b	21-20721	1	Angular wheel	36	21-13564	1	Mains cable with screw
6	21-20731	1	Helical ball bearing	38	21-13560	1	Housing primary operation unit
7	21-20041	4	Hex. allen screw	39	21-20078	4	Screws
8	21-13502	1	Bearing plate gear	40	21-13562	1	On/Off switch (Power Supply)
9	21-13504	1	EF ventilating wheel	42	21-13569	3	Cap (push button)
10	21-13505	1	EF spoiler	43	21-13561	3	Push button trigger
11	21-13618	1	Rotor	44	21-13550	1	Panel electronic complete 45-49
12	21-20728	2	Stud bolt	45	21-13513	1	Cooling unit
13	21-13507	1	EF motor feather key	46	21-13551	1	Power module
14	21-20740	1	Pretension spring EF motor	47	21-13552	1	Circuit board
15	21-20730	1	Deep groove ball bearing	48	21-13553	1	Logic circuit board
16	21-13503	1	Bearing plate ELO	49	21-13554	1	Mains filter
17	21-13508	1	Hard ferrite magnetic support	60	21-13531	1	Operation unit LCD compl. 61-67
18	21-13514	2	Adjusting washer	61	21-13540	1	Operating cover
19	21-13515	1	Hard ferrite magnet	62	21-13536	1	Keyboard foil LCD
20	21-20722	1	Seeger circlip ring	63	21-13542	1	Acrylic glass
21	21-13511	1	Hall sensor circuit	64	21-13541	1	Rubber frame
22	21-20725	1	Intermediate washer	65	21-13538	1	Operation housing LCD
23	21-20724	1	Counter sunk screw	66	21-13538	1	Operation electronic LCD
24	21-20723	3	Hex allen screw	67	21-13539	1	Profile gasket
25	21-13529	1	Closing plate operation unit				

EFW800 Plus (Angle Gear Box)

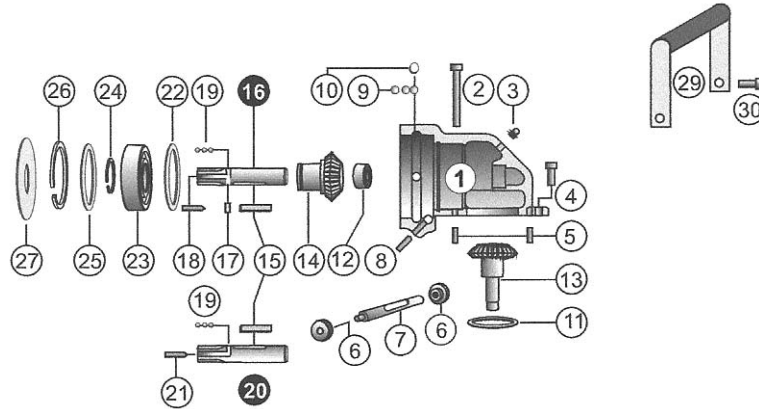

Ref #	Part #	Quantity	Description
1	21-13912	1	Angle housing finished part
2	21-20771	2	Hex allen screw
3	21-20767	1	Deflection-ball bearing lubricator
4	21-20075	3	Allen screw
5	21-20001	2	Parallel pin
6	21-20769	2	Knurled nut
7	21-13931	1	Blocking pin
8	21-20768	1	Pressure unit flexible
9	21-20108	30	Ball
10	21-12419	1	Closing roll
11	21-20765	1	Nilos-ring
12	21-20761	1	Needle sleeve
13	21-139...	1	Pinion: Z: 22 Z: 20 Z:15
14	21-139...	1	Bevel gear Z: 22 Z: 20 Z:15
15	21-20283	1	Feather key
16	21-13927	1	Motor Shaft Z 8
17	21-20284	1	Stud bolt
18	21-20282	1	Stud bolt
19	21-20109	2	Ball
20	21-13928	1	Motor shaft Z11
	21-13929	1	Motor shaft Z17
21	21-20281	1	Stud bolt M5
22	21-20762	1	Adjusting washer
23	21-20760	1	Deep groove ball bearing
24	21-20766	1	Circlip
25	21-20764	1	Nilos-ring
26	21-20763	1	Circlip
27	21-20780	1	Stop washer
29	21-16881	1	Bow type handle
30	21-20076	2	Allen screw

EFW800 Plus Gearing

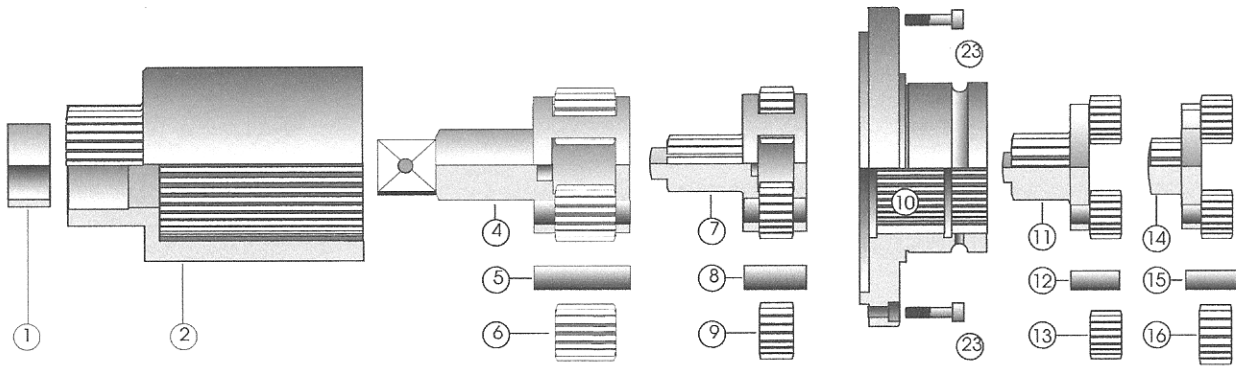

Ref #	Part #	Quantity	Description
1	21-20141	1	Sleeve
2	21-10301	1	Gear housing
4	21-10308	1	Gear cage 1 1/2"
5	21-20015	4	Bearing pins
6	21-10306	4	Planet gears
7	21-10304	1	Gear cage
8	21-20013	3	Bearing pins
9	21-10307	3	Planet gears
10	21-12415	1	Rotary housing
11	21-10164	1	Gear cage L
12	21-10142	3	Bearing pins
13	21-10145	3	Planet gears
14	21-10149	1	Gear cage
15	21-10142	3	Bearing pins
16	21-10145	3	Planet gears
23	21-20062	4	Hexagon Screw